

SLV-478/677HF/678HF/688HF/L47/L48/L57/ L58/L67HF/L68HF/L77HF/L78HF/X50/X60HF RMT-V230/V231/V231A/V231B/V232

SERVICE MANUAL

Hi-Fi

VHS



Photo : SLV-478

- Refer to the **SERVICE MANUAL of VHS MECHANICAL ADJUSTMENT VI for MECHANICAL ADJUSTMENTS. (9-921-647-11)**

US Model

SLV-677HF/678HF/688HF

Canadian Model

SLV-478/677HF/678HF

Mexican Model

SLV-L47/L57/L67HF/L77HF/X50/X60HF

Panamanian Model

SLV-L47/L58/L67HF/L78HF

Venezueran Model

SLV-L48/L58/L68HF/L78HF

S MECHANISM

HiFi model: SLV-677HF/678HF/688HF/L67HF/L68HF/L77HF/L78HF/X60HF
Mono model: SLV-478/L47/L48/L57/L58/X50

SPECIFICATIONS

System

- Format
 - VHS NTSC standard
- Video recording system
 - Rotary head helical scanning FM system
- Video heads
 - Double azimuth four heads
- Video signal
 - NTSC color, EIA standards
- Tape speed
 - SP: 33.35 mm/s (1³/₈ inches/s)
 - EP: 11.11 mm/s (7/₁₆ inches/s)
 - LP: 16.67 mm/s (11/₁₆ inches/s), playback only
- Maximum recording/playback time
 - 8 hrs. in EP mode (with T-160 tape)
- Fast-forward and rewind time
 - Approx. 3 min. (with T-120 tape)

Tuner section

- Channel coverage
 - VHF 2 to 13
 - UHF 14 to 69
 - CATV A-8 to A-1, A to W, W+1 to W+84
- Antenna
 - 75-ohm antenna terminal for VHF/UHF

Inputs and outputs

- LINE-1 IN and LINE-2 IN
 - VIDEO IN, phono jack (1 each)
 - Input signal: 1 V_{p-p}, 75 ohms, unbalanced, sync negative
- AUDIO IN, phono jacks (2 each)
 - Input level: 327 mVrms
 - Input impedance: more than 47 kilohms
- LINE OUT
 - VIDEO OUT, phono jack (1)
 - Output signal: 1 V_{p-p}, 75 ohms, unbalanced, sync negative
- AUDIO OUT, phono jacks (2)
 - Standard output: 327 mVrms
 - Load impedance: 47 kilohms
 - Output impedance: less than 10 kilohms
- CABLE BOX CONTROL (CONTROL S OUT) (688HF)
 - Stereo mini jack (plug in power) (1)

Timer section

- Clock
 - Quartz locked
- Timer indication
 - 12-hour cycle
- Timer setting
 - 8 programs per month (max.)
- Power back-up
 - Built-in self-charging capacitor
 - Back-up duration: up to 1 hour at a time

General

- Power requirements
 - 120 V AC, 60 Hz
- Power consumption
 - L47/L48/L57/L58/X50: 18W
 - L67HF/L68HF/L77HF/L78HF/X60HF: 19W
 - 478: 23W
 - 677HF/678HF/688HF: 24W
- Operating temperature
 - 5°C to 40°C (41°F to 104°F)
- Storage temperature
 - 20°C to 60°C (-4°F to 140°F)
- Dimensions
 - Approx. 355 × 96 × 285 mm (w/h/d)
 - (Approx. 14 × 3³/₄ × 11¹/₄ inches) including projecting parts and controls
- Mass
 - Approx. 3.7 kg (8 lb 3 oz)
- Supplied accessories
 - Remote commander (1)
 - Size AA (R6) batteries (2)
 - 75-ohm coaxial cable with F-type connectors (1)
 - Audio/video cable (3 phono to 3 phono) (1)
- Design and specifications are subject to change without notice.

VIDEO CASSETTE RECORDER



SONY®

DIFFERENT SPECIFICATIONS

MODEL	SLV-478	SLV-677HF	SLV-678HF	SLV-688HF	SLV-L47	SLV-L48	SLV-L57	SLV-L58
SPECIFICATIONS								
AUDIO SYSTEM	MONAURAL	HiFi-STEREO		HiFi-STEREO	MONAURAL		MONAURAL	
TUNER AUDIO (STEREO) SYSTEM	—	SAP		SAP	—		—	
VCR+ SYSTEM	—	—		BUILT-IN	—		—	
LINE 2 INPUT	—	—		BUILT-IN	—		BUILT-IN	
BODY COLOR	BLACK	TITAN	BLACK	BLACK	BLACK		BLACK	
DUAL MODE SHUTTLE	—	—		—	—		BUILT-IN	
REMOTE COMMANDER	RMT-V231A	RMT-V231A		RMT-V231B	RMT-V230		RMT-V232	

MODEL	SLV-L67HF	SLV-L68HF	SLV-L77HF	SLV-L78HF	SLV-X50	SLV-X60HF
SPECIFICATIONS						
AUDIO SYSTEM	HiFi-STEREO		HiFi-STEREO		MONAURAL	HiFi-STEREO
TUNER AUDIO (STEREO) SYSTEM	SAP		SAP		—	SAP
VCR+ SYSTEM	—		—		—	—
LINE 2 INPUT	—		BUILT-IN		—	—
BODY COLOR	BLACK	TITAN	BLACK	TITAN	TITAN	TITAN
DUAL MODE SHUTTLE	—		BUILT-IN		BUILT-IN	—
REMOTE COMMANDER	RMT-V231		RMT-V232		RMT-V232	RMT-V231

SAFETY-RELATED COMPONENT WARNING!!

COMPONENTS IDENTIFIED BY MARK \triangle OR DOTTED LINE WITH MARK \triangle ON THE SCHEMATIC DIAGRAMS AND IN THE PARTS LIST ARE CRITICAL TO SAFE OPERATION. REPLACE THESE COMPONENTS WITH SONY PARTS WHOSE PART NUMBERS APPEAR AS SHOWN IN THIS MANUAL OR IN SUPPLEMENTS PUBLISHED BY SONY.

ATTENTION AU COMPOSANT AYANT RAPPORT À LA SÉCURITÉ!

LES COMPOSANTS IDENTIFIÉS PAR UNE MARQUE \triangle SUR LES DIAGRAMMES SCHÉMATIQUES ET LA LISTE DES PIÈCES SONT CRITIQUES POUR LA SÉCURITÉ DE FONCTIONNEMENT. NE REMPLACER CES COMPOSANTS QUE PAR DES PIÈCES SONY DONT LES NUMÉROS SONT DONNÉS DANS CE MANUEL OU DANS LES SUPPLÉMENTS PUBLIÉS PAR SONY.

SAFETY CHECK-OUT

After correcting the original service problem, perform the following safety checks before releasing the set to the customer.

1. Check the area of your repair for unsoldered or poorly-soldered connections. Check the entire board surface for solder splashes and bridges.
2. Check the interboard wiring to ensure that no wires are "pinched" or contact high-wattage resistors.
3. Look for unauthorized replacement parts, particularly transistors, that were installed during a previous repair. Point them out to the customer and recommend their replacement.
4. Look for parts which, though functioning, show obvious signs of deterioration. Point them out to the customer and recommend their replacement.
5. Check the line cord for cracks and abrasion. Recommend the replacement of any such line cord to the customer.
6. Check the B+ voltage to see it is at the values specified.
7. Check the antenna terminals, metal trim, "metallized" knobs, screws, and all other exposed metal parts for AC leakage. Check leakage as described below.

LEAKAGE TEST

The AC leakage from any exposed metal part to earth ground and from all exposed metal parts to any exposed metal part having a return to chassis, must not exceed 0.5mA (500 microampers). Leakage current can be measured by any one of three methods.

1. A commercial leakage tester, such as the Simpson 229 or RCA TW-540A. Follow the manufacturers' instructions to use these instruments.
2. A battery-operated AC milliammeter. The Data Precision 245 digital multimeter is suitable for this job.
3. Measuring the voltage drop across a resistor by means of a VOM or battery-operated AC voltmeter. The "limit" indication is 0.75V, so analog meters must have an accurate low voltage scale. The Simpson 250 and Sanwa SH-63Trd are examples of a passive VOM that is suitable. Nearly all battery operated digital multimeters that have a 2V AC range are suitable. (See Fig. A)

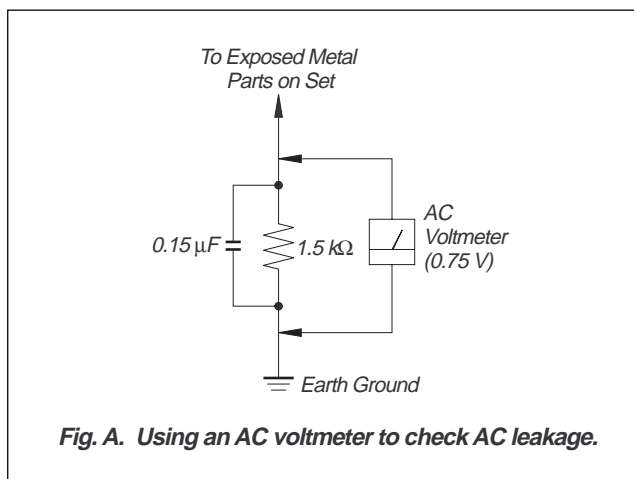

Fig. A. Using an AC voltmeter to check AC leakage.

TABLE OF CONTENTS

SERVICE NOTE

1. ERROR CODE INDICATION	6
2. HOW TO REPLACE A ROTARY UPPER DRUM (HiFi MODEL)	7
2-1. HOW TO REMOVE A ROTARY UPPER DRUM	7
2-2. HOW TO ATTACH A NEW ROTARY UPPER DRUM	7

1. GENERAL

Getting Started

Unpacking	1-1
Setting up the remote commander	1-1
Hookups	1-1
Selecting a language	1-7
Setting the clock	1-7
Setting up cable box control	1-7
Presetting channels	1-9
Setting up VCR Plus+	1-10

Basic Operations

Playing a tape	1-11
Recording TV programs	1-11
Recording TV programs using VCR Plus+	1-12
Setting the timer manually	1-13

Additional Operations

Playing/searching at various speeds	1-14
Searching for a selected point on the tape	1-14
Skip-searching automatically	1-14
Recording TV programs using the quick timer	1-15
Checking/changing/cancelling timer settings	1-15
Recording stereo and bilingual programs	1-15
Adjusting the picture	1-16
Changing menu options	1-16
Editing with another VCR	1-16

Additional Information

General setup information	1-17
Troubleshooting	1-17
Index to parts and controls	1-18

2. DISASSEMBLY

2-1. UPPER CASE, FRONT PANEL BLOCK ASSEMBLY	2-1
2-2. DS-79 BOARD, JK-161 BOARD	2-1
2-3. REAR PANEL	2-2
2-4. MA-317 BOARD WITH S MECHANISM DECK ASSEMBLY	2-2
2-5. S MECHANISM DECK ASSEMBLY, MA-317 BOARD	2-3
2-6. INTERNAL VIEWS	2-4
2-7. CIRCUIT BOARDS LOCATION	2-5

3. BLOCK DIAGRAMS

3-1. OVERALL BLOCK DIAGRAM	3-1
3-2. VIDEO BLOCK DIAGRAM	3-4
3-3. SERVO/SYSTEM CONTROL BLOCK DIAGRAM	3-5
3-4. AUDIO BLOCK DIAGRAM	3-7
3-5. TUNER BLOCK DIAGRAM	3-9
3-6. POWER SUPPLY BLOCK DIAGRAM	3-11

4. PRINTED WIRING BOARDS AND SCHEMATIC DIAGRAMS

4-1. FRAME SCHEMATIC DIAGRAM	4-1
4-2. PRINTED WIRING BOARDS AND SCHEMATIC DIAGRAMS	4-3
• MA-317 (REC/PB AMP, VIDEO, SERVO/SYSTEM CONTROL, AUDIO, MODE CONTROL, TUNER, POWER SUPPLY) PRINTED WIRING BOARD	4-3

• MA-317 (REC/PB AMP) SCHEMATIC DIAGRAM	4-5
• MA-317 (VIDEO) SCHEMATIC DIAGRAM	4-8
• MA-317 (SERVO/SYSTEM CONTROL) SCHEMATIC DIAGRAM	4-11
• MA-317 (AUDIO) SCHEMATIC DIAGRAM	4-15
• MA-317 (MODE CONTROL) SCHEMATIC DIAGRAM	4-17
• MA-317 (TUNER) SCHEMATIC DIAGRAM	4-19
• MA-317 (POWER SUPPLY) SCHEMATIC DIAGRAM	4-21
• DS-79 (OPERATION SWITCHES) PRINTED WIRING BOARD AND SCHEMATIC DIAGRAM	4-23
• JK-161 (LINE IN 2) PRINTED WIRING BOARD AND SCHEMATIC DIAGRAM	4-24

5. INTERFACE, IC PIN FUNCTION DESCRIPTION

5-1. SYSTEM CONTROL — MECHANISM BLOCK INTERFACE (MA-317 BOARD IC160)	5-1
5-2. SYSTEM CONTROL — SERVO PERIPHERAL CIRCUIT INTERFACE (MA-317 BOARD IC160)	5-1
5-3. SYSTEM CONTROL — SYSTEM CONTROL PERIPHERAL CIRCUIT INTERFACE (MA-317 BOARD IC160)	5-2
5-4. SYSTEM CONTROL AND RF MODULATOR— INPUT SELECTION BLOCK INTERFACE (MA-317 BOARD IC160)	5-2
5-5. SYSTEM CONTROL — VIDEO/RP BLOCK INTERFACE (MA-317 BOARD IC160)	5-2
5-6. SYSTEM CONTROL — AUDIO BLOCK INTERFACE (MA-317 BOARD IC160)	5-2
5-7. SERVO/SYSTEM CONTROL MICROPROCESSOR (MA-317 BOARD IC160)	5-3

6. ADJUSTMENTS

6-1. MECHANICAL ADJUSTMENTS	6-1
6-2. ELECTRICAL ADJUSTMENTS	6-1
2-1. PREPARATION BEFORE ADJUSTMENT	6-1
2-1-1. Equipment Required	6-1
2-1-2. Equipment Connection	6-1
2-1-3. Input Signal Check	6-1
2-1-4. Alignment Tape	6-1
2-1-5. Input/Output Levels and Impedance	6-2
2-1-6. Adjustment Sequence	6-2
2-2. POWER SUPPLY CHECK	6-2
2-2-1. Output Voltage Check (MA-317 Board)	6-2
2-3. SERVO SYSTEM CHECK	6-3
2-3-1. RF Switching Position/ AF Switching Position Adjustments (MA-317 Board)	6-3
2-4. VIDEO SYSTEM CHECKS AND ADJUSTMENT	6-4
2-4-1. X'tal OSC Check (MA-317 Board)	6-4
2-4-2. SYNC AGC Check (MA-317 Board)	6-4
2-4-3. White Clip/Dark Clip Check (MA-317 Board)	6-4
2-4-4. Recording Y Level Check (MA-317 Board)	6-5
2-4-5. Recording Chroma Level Check (MA-317 Board)	6-5
2-4-6. Playback Level Check (MA-317 Board)	6-5

2-5. AUDIO SYSTEM ADJUSTMENT	6-6
2-5-1. ACE Head Adjustment	6-6
2-5-2. E-E Output Level Check	6-6
2-5-3. Overall Output Level and Distortion Factor Check	6-6
2-5-4. Overall Noise Level Check	6-6
2-6. TUNER SYSTEM ADJUSTMENT (HiFi MODEL)	6-6
2-6-1. Separation Adjustment (MA-317 Board)	6-6
2-7. ADJUSTING PARTS LOCATION DIAGRAM	6-8

7. REPAIR PARTS LIST

7-1. EXPLODED VIEWS	7-1
7-1-1. FRONT PANEL ASSEMBLY AND UPPER CASE SECTION	7-1
7-1-2. CHASSIS SECTION	7-2
7-1-3. MECHANISM DECK-1	7-3
7-1-4. MECHANISM DECK-2	7-4
7-1-5. MECHANISM DECK-3	7-5
7-2. ELECTRICAL PARTS LIST	7-6

SERVICE NOTE

1. ERROR CODE INDICATION

- Error codes are indicated using the lower 5 digits in the fluorescent display tube.
“At this time, Colon “:” between character is not indicated.”

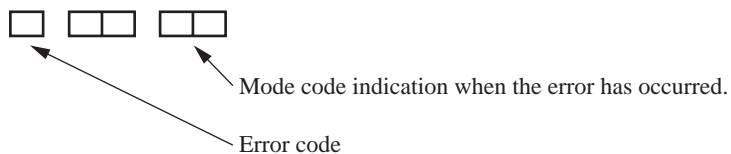

ERROR CODE

0	No error
1	Cam encoder error Loading direction
2	Cam encoder error Unloading direction
3	T reel error
4	S reel error
5	Capstan error
6	Drum error
7	Error on initializing
8	Cassette loading error
9	Reserve

MODE CODE

0	Power-on eject	10	FWD x1	20	REW play
1	Power-on initial	11	FWD x2	21	Cas. loading
2	Power-off eject	12	CUE	22	Tape loading
3	Power-off stop	13	PB-pause	23	Power-off loading
4	FF	14	RVS-pause	24	Mecha. error (Power on)
5	REW	15	RVS x1	25	Power-on eject initial
6	REC	16	RVS x2	26	Power-off eject initial
7	REC- pause	17	REV	27	APC REC
8	Power-on stop	18	Power-off initial	28	Cas. loading
9	PB	19	Mecha. error (Power off)		(No auto PB check)

2. HOW TO REPLACE A ROTARY UPPER DRUM (HiFi MODEL)

See below for note.

2-1. HOW TO REMOVE A ROTARY UPPER DRUM

- 1) Remove screw ① (+P3 × 8) and remove the ground shaft assembly ②. (Refer to Fig. 4.)
- 2) Remove soldering which is marked by arrow and remove the rotary upper drum board completely.
- 3) Remove two screws ③ (PSW3 × 8) and remove the rotary upper drum in the direction of A. (Refer to Fig. 5.)
If removal is difficult, remove it while rotating it slowly.

Note: If removal is difficult, check again if soldering is removed completely.

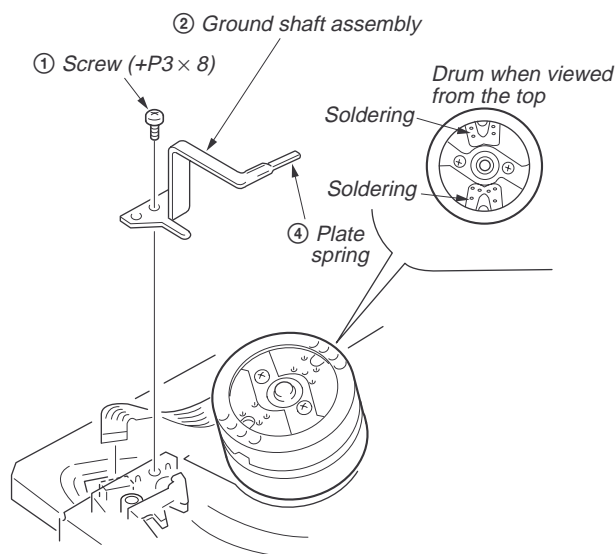

Fig. 4

2-2. HOW TO ATTACH A NEW ROTARY UPPER DRUM

- 1) Pay attention so that finger print or like must not be put when inserting a new upper drum into lower drum.
- 2) Align mark of the rotary upper drum board with the mark of the rotary transformer board so that the screw hole on the upper drum and that on the lower drum are aligned. (Refer to Fig. 5.)
- 3) If attaching is difficult, attach a upper drum while rotating it slowly.

Note: Pay attention not to damage the video heads.
Confirm that the upper drum is inserted completely.

- 4) Tighten the two screws ③ (PSW3 × 8). (Refer to Fig. 5.)
- 5) Fix the earth shaft ② by tightening the screw ① (+P3 × 8) so that protrusion at the tip of the earth shaft contacts the center of the drum shaft.

Note: When attaching the ground shaft assembly ②, never give force to the plate spring ④.

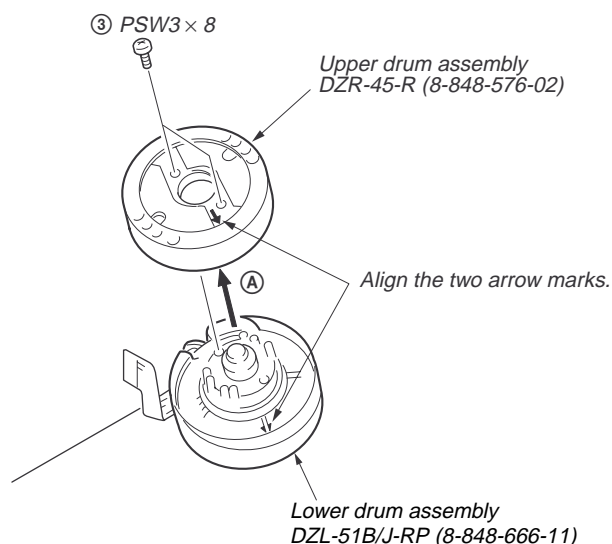
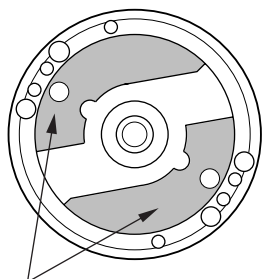

Fig. 5

NOTE : There are two types of drum assembly built in the HiFi models.

[Discrimination]

UPPER DRUM ASSEMBLY
DZR-45-R
(8-848-576-02)
—Top View—



There are two printed circuit boards on the top.

DRUM ASSEMBLY
DZH-94A/Z-RP
(8-839-044-02)
—Top View—

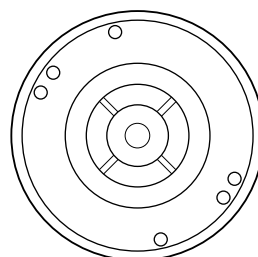

There is no printed circuit board.

Note: It cannot be divided to two parts, the upper and the lower drum assemblies.

SECTION 1
GENERAL

This section is extracted from
SLV-688HF nstruction manual.

Getting Started

Step 1

Unpacking

Check that you have received the following items with the VCR:

- Remote commander

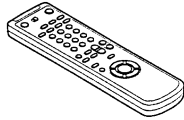

- Audio/video cable (3-phono to 3-phono)



- Size AA (R6) batteries



- 75-ohm coaxial cable with F-type connectors

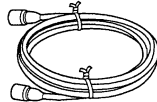

4 | Getting Started

Step 2

Setting up the remote commander

Inserting the batteries

Insert two size AA (R6) batteries by matching the + and - on the batteries to the diagram inside the battery compartment.

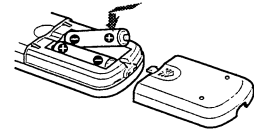

Insert the negative (-) end first, then push in and down until the positive (+) end clicks into position.

Using the remote commander

You can use this remote commander to operate this VCR and a Sony TV. Buttons on the remote commander marked with a dot (•) can be used to operate your Sony TV.

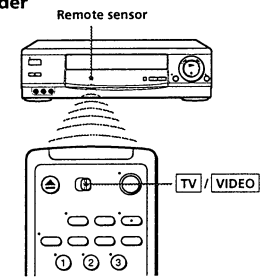

To operate the VCR	Set [TV/VIDEO] to [VIDEO] and point at the remote sensor on the VCR
a Sony TV	[TV] and point at the remote sensor on the TV

Notes

- With normal use, the batteries should last about three to six months.
- If you do not use the remote commander for an extended period of time, remove the batteries to avoid possible damage from battery leakage.
- Do not use a new battery with an old one.
- Do not use different types of batteries.

continued

Step 2: Setting up the remote commander (continued)

Controlling other TVs with the remote commander

The remote commander is preprogrammed to control non-Sony TVs. If your TV is listed in the table below, set the appropriate manufacturer's code number.

- 1 Set **[TV/VIDEO]** at the top of the remote commander to **[TV]**.
- 2 Hold **POWER** down, and enter your TV's code number(s) using the number buttons. Then release **POWER**.

Now you can use the **POWER**, **VOL +/-**, **CH +/-** and **TV/VIDEO** buttons to control your TV. You can also use the buttons marked with a dot (•) to control a Sony TV. To control the VCR, reset **[TV/VIDEO]** to **[VIDEO]**.

Code numbers of controllable TVs

If more than one code number is listed, try entering them one at a time until you find the one that works with your TV.

Manufacturer	Code number	Manufacturer	Code number	Manufacturer	Code number
Sony	01	JVC	09	RCA	04,10
Akai	04	KMC	03	Sampo	12
AOC	04	Magnavox	03,08,12	Sanyo	11
Centurion	12	Marantz	04,13	Scott	12
Coronado	03	MGA/Mitsubishi	04,12,13,17	Sears	07,10,11
Curis-Mathes	12	NEC	04,12	Sharp	03,05,18
Daytron	12	Panasonic	06,19	Sylvania	08,12
Emerson	03,04,14	Philco	03,04	Teknika	03,08,14
Fisher	11	Philips	08	Toshiba	07
General Electric	06,10	Pioneer	16	Wards	03,04,12
Gold Star	03,04,17	Portland	03	Yorx	12
Hitachi	02,03	Quasar	06,18	Zenith	15
J.C.Penny	04,12	Radio Shack	05,14		

Notes

- If the TV uses a different remote control system from the one programmed to work with the VCR, you cannot control your TV with the remote commander.
- If you enter a new code number, the code number previously entered will be erased.
- When you replace the batteries of the remote commander, the code number automatically resets to 01 (Sony). Reset the appropriate code number.

6 | Getting Started

Step 3

Hookups

Selecting the best hookup option

There are many ways in which your VCR can be hooked up. To hook up your VCR so that it works best for you, first scan through the table below. Then use the accompanying diagrams and procedures on the following pages to set up your VCR. For hookup 1 or 5, use the Sony RM-CM101 Cable Mouse (cable box controller) (not supplied).

If you have	Use	Refer to
TV that has audio/video inputs	Audio/video (A/V) hookup , then follow one of the hookups below.	Pages 8 and 9
Cable box that is compatible with the VCR's cable box control feature	Hookup 1	Pages 10 to 12
No cable box or incompatible cable box with only a few scrambled channels	Hookup 2	Pages 13 to 15
Antenna only, no cable TV	Hookup 3	Pages 16 to 18
Incompatible cable box with many scrambled channels	Hookup 4	Pages 19 to 21
DSS* receiver	Hookup 5	Pages 22 and 23
Incompatible cable box with only a few scrambled channels, using an A/B switch	Hookup 6	Pages 24 to 27

After you've completed the connections, follow the instructions for setup. During setup, if you need more details on the procedure described, page numbers are provided where you can find complete, step-by-step instructions.

After you've completed the setup, you're ready to use your VCR. Procedures differ depending on the hookup you used. For an overview, refer to "Quick reference to using the VCR" on the back cover.

Before you get started

- Turn off the power to all equipment.
- Do not connect the AC power cords until all of the connections are completed.
- Be sure you make connections firmly. Loose connections may cause picture distortion.
- If your TV doesn't match any of the examples provided, see your nearest Sony dealer or qualified technician.

* DSS* is a registered trademark of DIRECTV, Inc., a unit of Hughes Electronics Corporation.

Getting Started | 7

Step 3: Hookups (continued)

Audio/video (A/V) hookup

Pages 8 and 9

If your TV has audio/video (A/V) input jacks, you will get a better picture and sound when you hook up your VCR using these connections. In addition, for a true "home theater" experience, you should connect the audio outputs of your VCR or TV to your stereo system. If your TV doesn't have A/V inputs, see the following pages for antenna or cable hookups.

If you're not planning to use your VCR to record programs, you're finished setting up the VCR after you've made the connections shown on pages 8 and 9.

If you want to record off-air or off your cable TV system, complete these connections first, and then go to the following pages for antenna or cable hookups.

A Use this hookup if your TV has stereo jacks

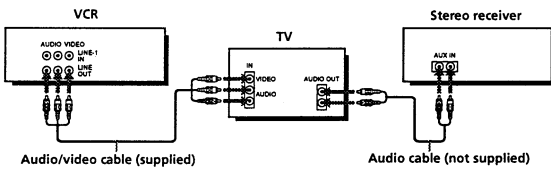

B Use this hookup if your TV doesn't have stereo jacks

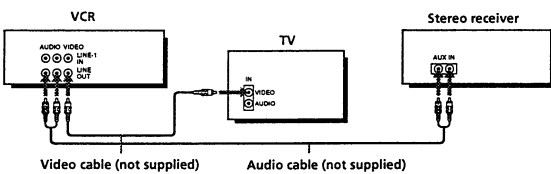

Note
To play a tape in stereo, you must use the A/V connection.

Caution

Connections between the VCR's VHF/UHF connector and the antenna terminals of the TV receiver should be made only as shown in the following instructions. Failure to do so may result in operation that violates the regulations of the Federal Communications Commission regarding the use and operation of RF devices. Never connect the output of the VCR to an antenna or make simultaneous (parallel) antenna and VCR connections at the antenna terminals of your receiver.

Note to CATV system installer (in USA)

This reminder is provided to call the CATV system installer's attention to Article 820-40 of the NEC that provides guidelines for proper grounding and, in particular, specifies that the cable ground shall be connected to the grounding system of the building, as close to the point of cable entry as practical.

Getting Started

Step 3: Hookups (continued)

Hookup 1

Pages 10 to 12

Using cable box control

Recommended use

You should use this hookup if you have a cable box, especially if your cable system scrambles all or most channels. This hookup allows the VCR's cable box control feature to control the channel on the cable box, simplifying the recording process. A list of compatible cable boxes is on pages 32 and 33.

What you can do with this hookup

- Record any channel using the VCR's cable box control feature to select channels on the cable box

What you can't do

- Record with the cable box turned off
- Record one channel while watching another channel

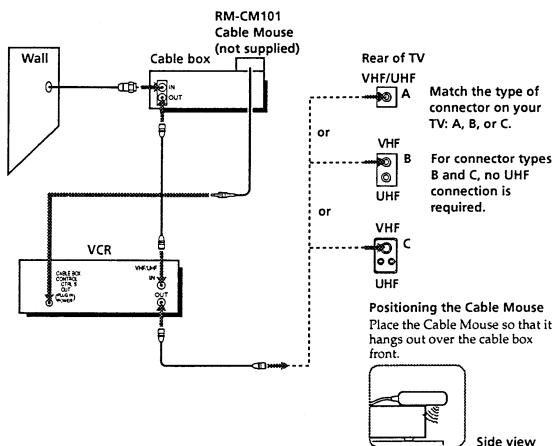

Hookup 1: VCR setup

- Set the RF UNIT switch to CH 3 or CH 4, whichever channel is not used in your area. If both are used, set the switch to either channel.

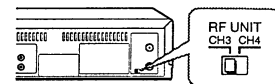

- Turn on your cable box.
- Press EASY SET UP on the VCR.

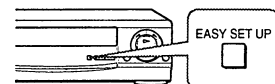

- The LANGUAGE menu appears. Change the on-screen display language to Spanish (ESPAÑOL) or French (FRANÇAIS) if desired, and press OK. For details, see page 28.
- The CLOCK SET menu appears. Set the clock and press OK. For details, see page 29.

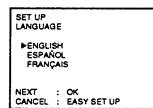

- The CABLE BOX CONTROL menu appears. Select ON. For details, see page 31.

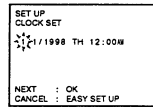

- Enter your cable box code number and press ↓. For details, see page 32.

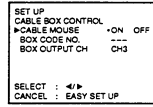

- Select your cable box output channel and press OK.

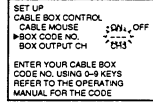
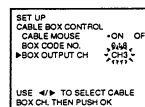

Normal display continued

Getting Started

Hookup 1: VCR Plus+ channel setup

- 1 Find the VCR Plus+ Channel Listing in your program guide. For details, see page 42.
- 2 If the channels in the program guide are different from the channels that you actually use on your TV, set the channels that are different as follows. For details, see page 43.
 - 1 Press MENU and select SET VCR PLUS+ CHANNELS.

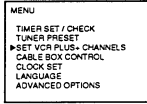

- 2 Enter the program guide channel, then the channel you use on your TV.

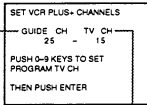

- 3 Press OK.

Program guide channel
Your actual TV channel

Hookup 2

No cable box, or compatible cable box with only a few scrambled channels

Recommended use

Use this hookup if you do not have a cable box. Also use this hookup if your cable company cannot supply a cable box that is compatible with the VCR's cable box control feature, and your cable system scrambles only a few channels.

What you can do with this hookup

- Record any unscrambled channel by selecting the channel on the VCR

What you can't do

- Record scrambled channels that require a cable box

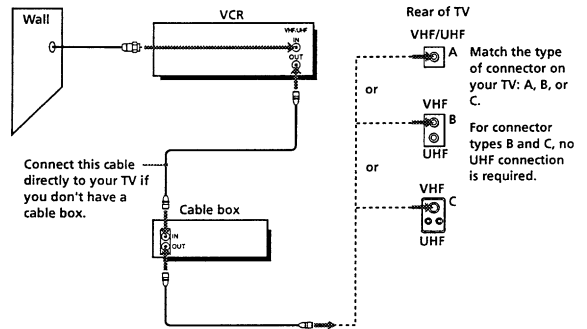

continued

Hookup 2: VCR setup

- 1 Set the RF UNIT switch to CH 3 or CH 4, whichever channel is not used in your area. If both are used, set the switch to either channel.

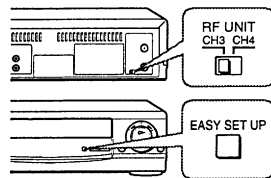

For details, see page 69. If you made A/V connections (from page 8), you can skip this step.

- 2 Press EASY SET UP on the VCR.

- 1 The LANGUAGE menu appears. Change the on-screen display language to Spanish (ESPAÑOL) or French (FRANÇAIS) if desired, and press OK. For details, see page 28.

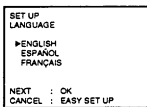

- 2 The CLOCK SET menu appears. Set the clock and press OK. For details, see page 29.

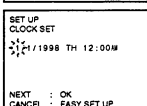

- 3 The CABLE BOX CONTROL menu appears. Select OFF and press OK.

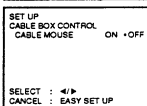

- 4 The TUNER PRESET menu appears. Set ANTENNA / CABLE to CABLE and press OK. For details, see page 36.

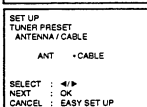

- 5 The AUTO PRESET starts.

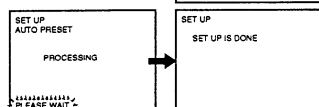

Normal display

Hookup 2: VCR Plus+ channel setup

- 1 Find the VCR Plus+ Channel Listing in your program guide. For details, see page 42.
- 2 If the channels in the program guide are different from the channels that you actually use on your TV, set the channels that are different as follows. For details, see page 43.
 - 1 Press MENU and select SET VCR PLUS+ CHANNELS.

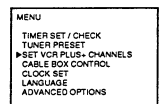

- 2 Enter the program guide channel, then the channel you use on your TV.

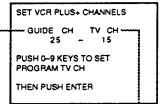

- 3 Press OK.

Program guide channel
Your actual TV channel

Hookup 3

Pages 16 to 18

Antenna hookup

Make the following connections if you're using an antenna (if you don't have cable TV).

A Use this hookup if you're using:

- VHF/UHF antenna (you get channels 2-13 and channels 14 and higher)
- UHF-only antenna (you get channels 14 and higher)
- Separate VHF and UHF antennas

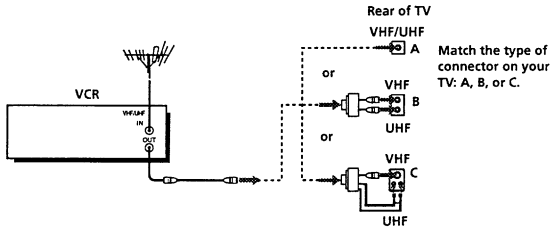

B Use this hookup if you're using a VHF-only antenna (you get channels 2-13 only)

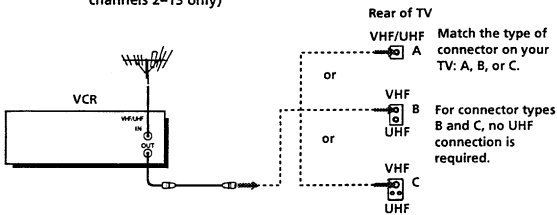

If you cannot connect your antenna cable to the VCR directly
If your antenna cable is a flat cable (300-ohm twin lead cable), attach an external antenna connector (not supplied) so that you can connect the cable to the VHF/UHF IN connector. If you have separate cables for VHF and UHF antennas, you should use a U/V band mixer (not supplied). For details, see page 70.

Hookup 3: VCR setup

- 1 Set the RF UNIT switch to CH 3 or CH 4, whichever channel is not used in your area. If both are used, set the switch to either channel.

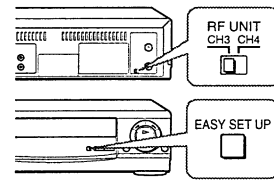

For details, see page 69. If you made A/V connections (from page 8), you can skip this step.

- 2 Press EASY SET UP on the VCR.

- 1 The LANGUAGE menu appears. Change the on-screen display language to Spanish (ESPAÑOL) or French (FRANÇAIS) if desired, and press OK. For details, see page 28.

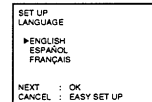

- 2 The CLOCK SET menu appears. Set the clock and press OK. For details, see page 29.

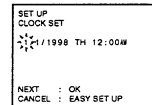

- 3 The CABLE BOX CONTROL menu appears. Select OFF and press OK.

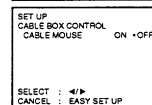

- 4 The TUNER PRESET menu appears. Set ANTENNA/CABLE to ANT and press OK. For details, see page 36.

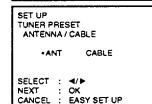

- 5 The AUTO PRESET starts.

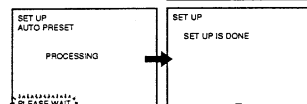

Normal display continued

Hookup 3: VCR Plus+ channel setup

- 1 Find the VCR Plus+ Channel Listing in your program guide. For details, see page 42.
- 2 If the channels in the program guide are different from the channels that you actually use on your TV, set the channels that are different as follows. For details, see page 43.

- 1 Press MENU and select SET VCR PLUS+ CHANNELS.

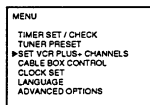

- 2 Enter the program guide channel, then the channel you use on your TV.

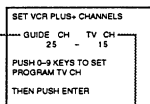

- 3 Press OK.

Program guide channel
Your actual TV channel

Hookup 4

Pages 19 to 21

Incompatible cable box with many scrambled channels

Recommended use

Use this hookup if your cable company cannot supply a cable box that is compatible with the VCR's cable box control feature, and your cable system scrambles all or most channels.

What you can do with this hookup

- Record any channel by selecting the channel on the cable box

What you can't do

- Record with the cable box turned off
- Record one channel while watching another channel
- Select channels directly on the VCR

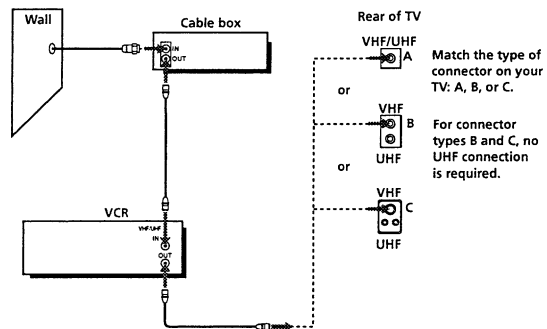

continued

Step 3: Hookups (continued)

Hookup 4: VCR setup

- 1 Set the RF UNIT switch to CH 3 or CH 4, whichever channel is not used in your area. If both are used, set the switch to either channel.
For details, see page 69. If you made A/V connections (from page 8), you can skip this step.
- 2 Turn on your cable box.
- 3 Press EASY SET UP on the VCR.

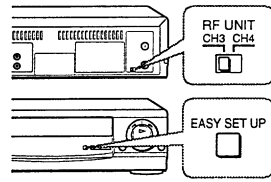

- 1 The LANGUAGE menu appears. Change the on-screen display language to Spanish (ESPAÑOL) or French (FRANÇAIS) if desired, and press OK. For details, see page 28.
- 2 The CLOCK SET menu appears. Set the clock and press OK. For details, see page 29.
- 3 The CABLE BOX CONTROL menu appears. Select OFF and press OK.
- 4 The TUNER PRESET menu appears. Set ANTENNA/CABLE to ANT and press OK. For details, see page 36.
- 5 The AUTO PRESET starts.

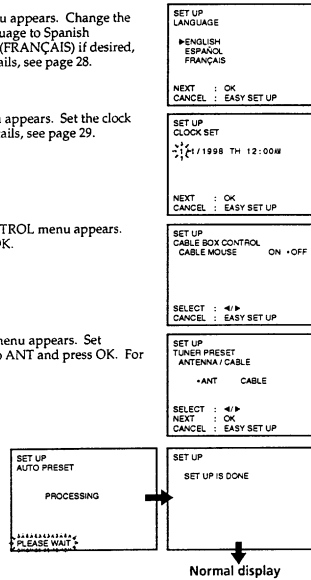

Hookup 4: VCR Plus+ channel setup

- 1 Find the VCR Plus+ Channel Listing in your program guide. For details, see page 42.
- 2 Enter all the channels you want to record and the cable box output channel (usually 2, 3, or 4). For details, see page 43.
 - 1 Press MENU and select SET VCR PLUS+ CHANNELS.
 - 2 Enter the program guide channel, then the cable box output channel.
 - 3 Press OK.

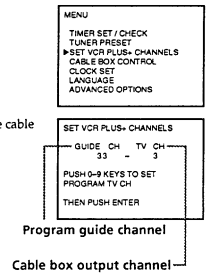

Getting Started

Step 3: Hookups (continued)

Hookup 5

Pages 22 and 23

DSS (Digital Satellite System) receiver

Recommended use

Use this hookup if you have a DSS receiver. It allows the VCR's cable box control feature to control the channel on the DSS receiver, simplifying the recording process. A list of compatible DSS receivers is on page 32.

DSS (Digital Satellite System) is a satellite broadcast that provides superior digital-quality video and crisp digital-quality audio. A variety of program packages are available through your program providers. It also has program guides that are sorted by program categories.

What you can do with this hookup

- Record any channels using the VCR's cable box control feature to select channels on the DSS receiver

What you can't do

- Record with the DSS receiver turned off
- Record any channels from cable or an antenna (To record channels from cable or an antenna, turn off the cable box control feature.)
- Use a cable box
- Record programs with VCR Plus+

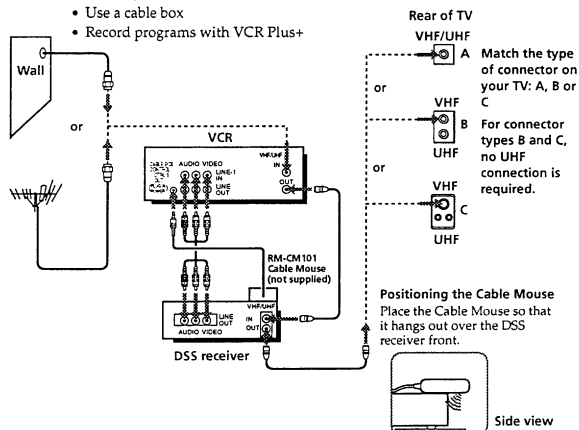

Hookup 5: VCR setup

- 1 Set the RF UNIT switch to CH 3 or CH 4, whichever channel is not used in your area. If both are used, set the switch to either channel.
For details, see page 69. If you made A/V connections (from page 8), you can skip this step.
- 2 Turn on your DSS receiver.
- 3 Press EASY SET UP on the VCR.

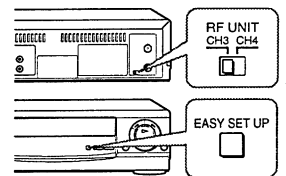

Getting Started

- 1 The LANGUAGE menu appears. Change the on-screen display language to Spanish (ESPAÑOL) or French (FRANÇAIS) if desired, and press OK. For details, see page 28.
- 2 The CLOCK SET menu appears. Set the clock and press OK. For details, see page 29.
- 3 The CABLE BOX CONTROL menu appears. Select ON. For details, see page 31.
- 4 Enter your DSS receiver code number and press ↓. For details, see page 32.
- 5 Set your DSS receiver output channel (BOX OUTPUT CH) to LINE and press OK.

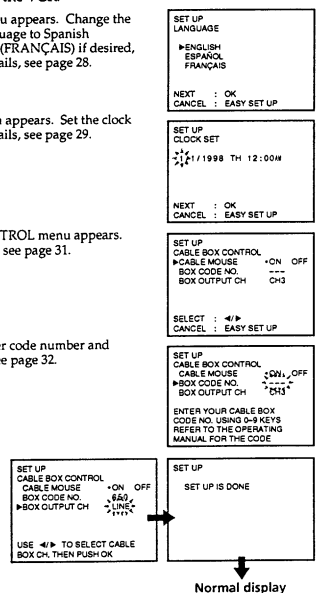

Hookup 6

Pages 24 to 27

Incompatible cable box with only a few scrambled channels, using an A/B switch

Recommended use

By using an A/B switch (not supplied), this hookup allows you to record both scrambled and unscrambled channels conveniently.

What you can do with this hookup

- Record any unscrambled channel by selecting the channel directly on the VCR (the A/B switch is set to A)
- Record any scrambled channel by selecting the channel on the cable box (the A/B switch is set to B)

What you can't do

- Record one scrambled channel while watching another channel (the A/B switch is set to B)

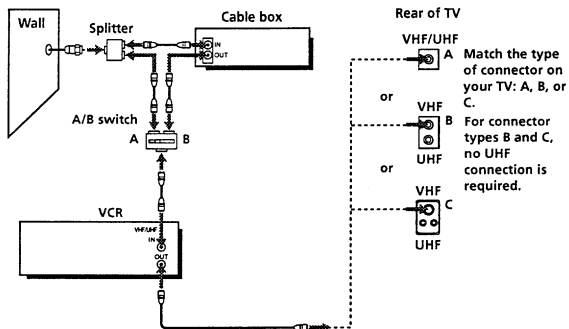

Hookup 6: VCR setup

- 1 Set the RF UNIT switch to CH 3 or CH 4, whichever channel is not used in your area. If both are used, set the switch to either channel.

For details, see page 69. If you made A/V connections (from page 8), you can skip this step.

- 2 Set the A/B switch to "A."

- 3 Press EASYSET UP on the VCR.

- 1 The LANGUAGE menu appears. Change the on-screen display language to Spanish (ESPAÑOL) or French (FRANÇAIS) if desired, and press OK. For details, see page 28.

- 2 The CLOCK SET menu appears. Set the clock and press OK. For details, see page 29.

- 3 The CABLE BOX CONTROL menu appears. Select OFF and press OK.

- 4 The TUNER PRESET menu appears. Set ANTENNA/CABLE to CABLE and press OK. For details, see page 36.

- 5 The AUTO PRESET starts.

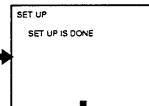
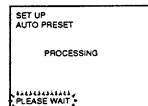
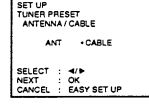
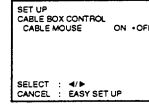
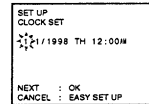
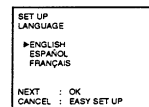
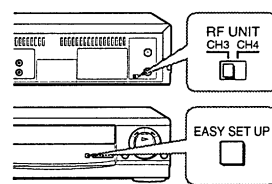

Normal display
continued

Getting Started

- 4 Preset the cable box output channel (usually 2, 3 or 4). For details, see page 38.

- 1 Press MENU and select TUNER PRESET.
- 2 Enter the cable box output channel.
- 3 Set MANUAL SET to ADD and press OK.

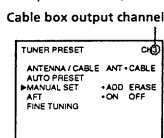

Hookup 6: VCR Plus+ channel setup

- 1 Find the VCR Plus+ Channel Listing in your program guide. For details, see page 42.
- 2 For unscrambled channels, if the channels in the program guide are different from the channels that you actually use on your TV, set the channels that are different as follows. For details, see page 43.

- 1 Press MENU and select SET VCR PLUS+ CHANNELS.

- 2 Enter the program guide channel, then the channel you use on your TV.

- 3 Press OK.

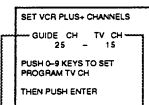
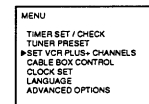

Program guide channel

Your actual TV channel

- 3 For scrambled channels, enter all the scrambled channels you want to record and the cable box output channel (usually 2, 3, or 4). For details, see page 43.

- 1 Press MENU and select SET VCR PLUS+ CHANNELS.

- 2 Enter the program guide channel, then the cable box output channel.

- 3 Press OK.

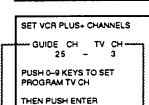
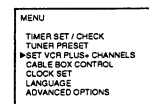

Program guide channel

Cable box output channel

Getting Started

Selecting a language

You can change the on-screen display language.

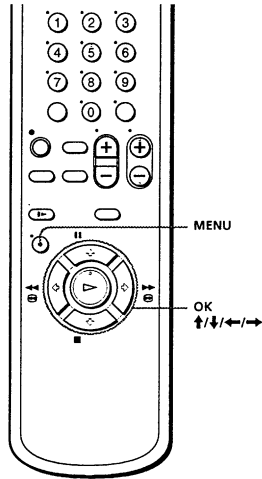



- 

Press MENU, then press \uparrow/\downarrow to move the cursor (\blacktriangleright) to LANGUAGE and press OK.



When using the EASY SET UP procedure, skip this step.

- 

Press \uparrow/\downarrow to select ENGLISH, ESPAÑOL, or FRANÇAIS, then press OK.

Setting the clock

Set the time and date to use the timer feature for recording programs.

Before you start...

- Turn on the VCR and the TV.
- Set the TV to the VCR channel (channel 3 or 4). If your TV is connected to the VCR using A/V connections, set the TV to video input.
- Press TV/VIDEO to display the VIDEO indicator in the VCR's display window.

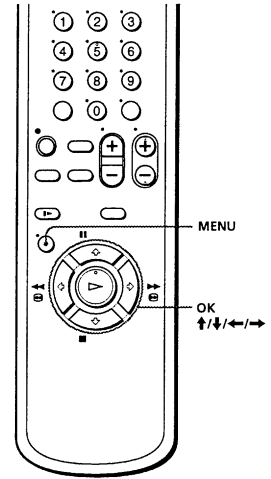



- 

Press MENU, then press \uparrow/\downarrow to move the cursor (\blacktriangleright) to CLOCK SET and press OK.

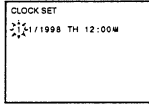

When using the EASY SET UP procedure, skip this step.

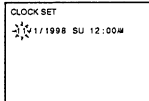

- 

Press \uparrow/\downarrow to set the month.





continued

Setting the clock (continued)

- 

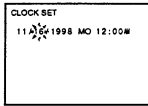
Press \rightarrow to flash the day and press \uparrow/\downarrow to set the day.
The day of the week is set automatically.

- 

Set the year, hour, and minutes in the same way as the day.
- 

Press OK to start the clock.

Setting up cable box control

(Skip this section if you are using Hookup 2, 3, 4 or 6.)

Your VCR includes a cable box control feature that allows the VCR to control most brands of cable boxes/DSS receivers via an optional Cable Mouse. With cable box control, the VCR controls channels on the cable box/DSS receiver for timer recording. You can also use the VCR's remote commander to change channels on the cable box/DSS receiver whenever the cable box/DSS receiver is turned on even if the VCR is turned off. To use cable box control, you need to connect the Sony RM-CM101 Cable Mouse (not supplied) (pages 10 and 22) and set the code number and output channel.

This VCR is programmed with codes necessary to control channel selection on most brands of cable boxes at the time this VCR was manufactured. It is possible that new cable boxes may be introduced that cannot be controlled with the RM-CM101 Cable Mouse. If you have a cable box that is incompatible with this VCR, contact your cable operator — they may be able to provide you with a compatible cable box.

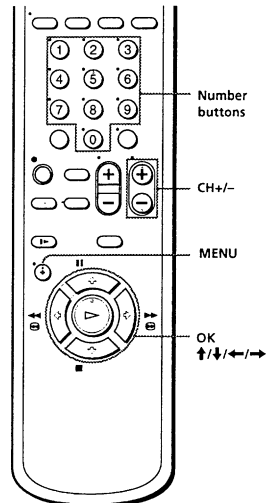



- 

Press MENU, then press \uparrow/\downarrow to move the cursor (\blacktriangleright) to CABLE BOX CONTROL and press OK.

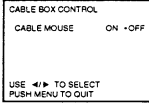

When using the EASY SET UP procedure, skip this step.

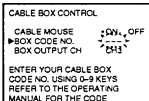

- 

Press \leftarrow/\rightarrow to select ON.
"---" flashes in the BOX CODE NO. row.
If a code number has already been entered, press \downarrow to select BOX CODE NO.



continued

Setting up cable box control (continued)

3  Press the number buttons to enter the cable box/DSS receiver code number, then press **↓**. Find your cable box/DSS receiver code number from the chart below.

CABLE BOX CONTROL

CABLE MOUSE ON OFF

BOX CODE NO. 024 028

BOX OUTPUT CH CH+ CH-

USE **CH+/-** TO SELECT CABLE BOX CH. THEN PUSH OK.



4  If you want to control a cable box, press **←/→** to select the output channel for the cable box, then press OK.

If you want to control a DSS receiver, select LINE, then press OK.

Cable box and DSS receiver brand and the corresponding code numbers
If more than one code number is listed, try entering them one by one, until you come to the correct code for your equipment.

Cable box brand	Code numbers
ABC	018, 022, 024, 028, 217
Antronix	218
Archer	033, 050, 164, 218, 808
BBT	278
Cable Star	067
Cabletenna	033
Cable time	172, 388, 459
Century	164
Citizen	164, 326, 327
Clyde Cablevision	097
Colour Voice	036, 042
Comband	243, 244
Comtronics	051, 071
Decsat	434
Diamond	046
Eagle Comtronics	051

Cable box brand	Code numbers
Eastern	013, 285
Electricord	089
Electus	055
Focus	411
Garrard	164
GC Electronics	027, 067, 341
GE	243, 244
GEC	097
Gemini	026, 068, 081
General Instrument	022, 287, 487
Hamlin	020, 031, 045, 270, 284
Hitachi	022
Jasco	164, 326
Jerrold	014, 022, 025, 026, 035, 037, 058, 109, 287, 487

Cable box brand	Code numbers
Linsay	451
Macom	044
Magnavox	038, 043, 080
Memorex	011
Movie Time	089, 167, 214
Northcoast	325
Novaplex	629
NSC	074, 081, 167, 214
Oak	018, 030, 259
Panasonic	032, 118
Paragon	011
Philips	036, 038, 039, 040, 041, 042, 071, 301
Pioneer	034, 155, 271, 544, 695
Popular Mechanics	411
Pulsar	011
Radio Shack	808
RCA	032
Realistic	218
Recoton	411
Regal	031, 270, 284, 290
Regency	013
Rembrandt	081
Samsung	051, 155
Scientific Atlanta	017, 019, 028, 288
Seam	521
Sharp	324
Signal	051
Signature	022
SL Marx	051
Spectravision	069
Sprucer	032, 318
Standard Components	107, 166
Starcom	014, 026, 058, 109
Stargate	026, 051
STS	167

Cable box brand	Code numbers
Sylvania	012
T-Cable Teletext	116
Tandy	269
Tatung	108
Teknica	157
TeleCaption	232
Teleservice	292
Texscan	012, 107
TFC	321
Timeless	429
Tocom	023, 024
Toshiba	011
Tudi	297
TV86	074
TV COM	018, 030, 259
Uniden	236
Unika	033, 164, 218
United Artists	018
United Cable	014
Universal	033, 050, 067, 088, 089, 164, 202, 218, 333
Videoway	261
Vidtech	255
Viewstar	038, 071, 074, 122, 222, 269, 300
Zenith	011, 065, 536
Zentek	411
Wave Master	576

DSS receiver brand	Code numbers
Hitachi	830
RCA	577
Sony	650
Toshiba	801

Setting up cable box control (continued)

To ensure correct operation

- Place the Cable Mouse so that it hangs out over the cable box/DSS receiver front.
- Do not place the cable box/DSS receiver on top of the VCR.
- Position the cable box/DSS receiver away from the VCR.
- Point the remote commander at the VCR, not at the cable box/DSS receiver.

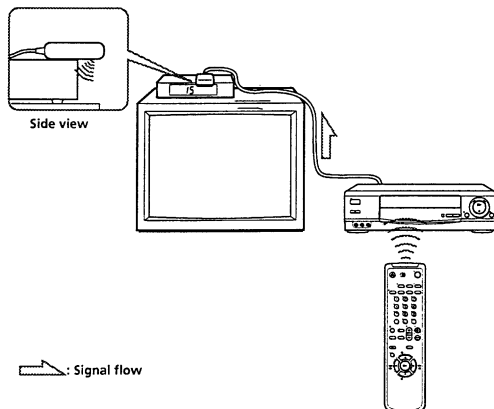

To check the cable box control setting

- 1 Press CH +/- on the remote commander. Does the channel indicator on the cable box/DSS receiver change? (Point the remote commander at the VCR, not at the cable box/DSS receiver.)
- 2 Press all 10 number buttons (0 to 9) on the remote commander. Does the channel indicator on the cable box/DSS receiver change?

If the answer to both 1 and 2 is "yes," you have made the correct setting.

If you cannot get your VCR to control the cable box/DSS receiver

- Check that the Cable Mouse is connected to the CABLE BOX CONTROL jack on the VCR.
- Check the position of the Cable Mouse.
- Place the cable box/DSS receiver and VCR away from each other. Do not place the cable box/DSS receiver on top of the VCR.
- Try the setup again making sure to use the correct control code. If the cable box still does not respond, try the other codes that are listed.

If your cable box still does not operate with the Cable Mouse, contact your cable company to see if they can provide you with a compatible cable box.

Note

- Make sure you turn off the VCR when you plug in or unplug the Cable Mouse. If you unplug the Cable Mouse and plug it in again, turn on the VCR before you use the cable box/DSS receiver control feature.

Presetting channels

(Skip this section if you are using cable box/DSS receiver control.)

This VCR is capable of receiving VHF channels 2 to 13, UHF channels 14 to 69 and unscrambled CATV channels 1 to 125. First, we recommend that you preset the receivable channels in your area using automatic presetting. Then, if there are any unwanted channels, disable them manually. If you have decided which channels you wish to preset, set them directly using manual presetting.

Before you start...

- Turn on the VCR and the TV.
- Set the TV to the VCR channel (channel 3 or 4). If your TV is connected to the VCR using A/V connections, set the TV to video input.
- Press TV/VIDEO to display the VIDEO indicator in the VCR's display window.

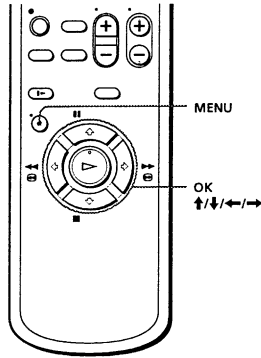

3

• To preset cable TV channels:
Press \leftarrow/\rightarrow to set ANTENNA/CABLE to CABLE.

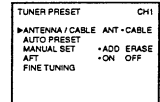

• To preset VHF and UHF channels:
Press \leftarrow/\rightarrow to set ANTENNA/CABLE to ANT.

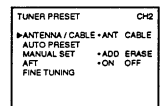

4

Press \uparrow/\downarrow to select AUTO PRESET, then press OK.



All receivable channels are preset in numerical sequence. When no more receivable channels can be found, presetting stops and the picture from the lowest numbered channel is displayed on the TV screen.

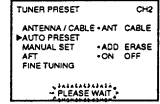

continued

Presetting all receivable channels automatically

1



Press MENU, then press \uparrow/\downarrow to move the cursor (\blacktriangleright) to TUNER PRESET and press OK.



When using the EASY SET UP procedure, skip this step.

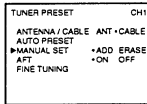

2



Press \uparrow/\downarrow to select ANTENNA/CABLE.

Presetting channels (continued)

Presetting/disabling channels manually

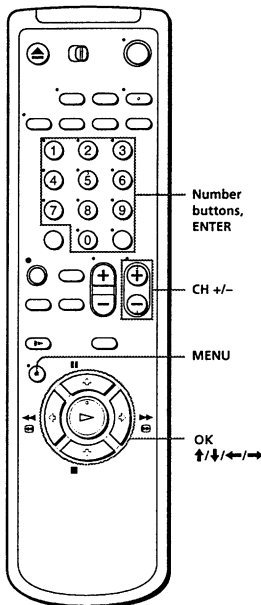

2

• To preset a channel:
1 Press the number buttons to enter the channel number, then press ENTER.
2 Press \leftarrow/\rightarrow to set MANUAL SET to ADD.

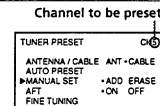

• To disable a channel:
1 Press CH +/- to select the channel number.
2 Press \leftarrow/\rightarrow to set MANUAL SET to ERASE.

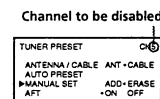

3

Repeat step 2 to preset or disable channels as required, then press OK.



continued

1



Press MENU and select TUNER PRESET, then press OK.

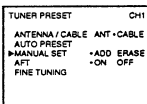

Presetting channels (continued)

If the picture is not clear

Normally, the Auto Fine Tuning (AFT) function automatically tunes in channels clearly. If, however, the picture of a channel is not clear, you can also use the manual tuning function.

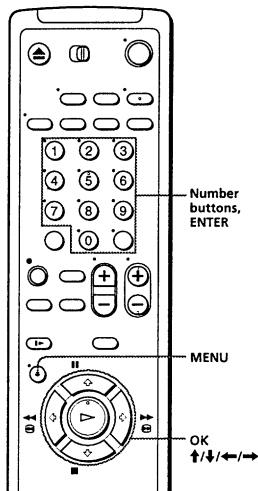

3 Press **↑/↓** to select FINE TUNING. The fine tuning meter appears.

4 Press **←/→** to adjust to a clearer picture, then press OK. Note that the AFT setting switches to OFF.

TUNER PRESET CH1

ANTENNA / CABLE ANT + CABLE

AUTO PRESET

MANUAL SET + ADD ERASE

AFT + ON - OFF

▶ FINE TUNING

TUNER PRESET CH5

ANTENNA / CABLE ANT + CABLE

AUTO PRESET

MANUAL SET + ADD ERASE

AFT + ON - OFF

▶ FINE TUNING

Tip

- To select the channel in step 2 above, you can also use the CH +/- buttons. In this case, you don't need to press ENTER.

1 Press MENU and select TUNER PRESET, then press OK.

TUNER PRESET CH1

ANTENNA / CABLE ANT + CABLE

AUTO PRESET

MANUAL SET + ADD ERASE

AFT + ON - OFF

▶ FINE TUNING

2 Press the number buttons to select the channel you want to fine-tune, then press ENTER.

Selected channel

TUNER PRESET CH0

ANTENNA / CABLE ANT + CABLE

AUTO PRESET

MANUAL SET + ADD ERASE

AFT + ON - OFF

▶ FINE TUNING

Setting up VCR Plus+

How VCR Plus+ works

Whenever you want to record a TV program, all you need to do is look up the program's "PlusCode," a number assigned to each program that's published in the TV section of most newspapers, cable TV listings, and even TV GUIDE magazine. Then, just enter the PlusCode of the program you want and the VCR is automatically programmed to record that show. It's that simple.

Example of "PlusCode"

5:30	MOVIE — Musical (2hrs.)	33041
6:00	SPORT — Golf (1hr. 25min.)	42060
	NEWS — WS 9974	
6:30	DRAMA — Comedy (2hrs.)	17390
	SCIENCE AND TECHNOLOGY (1hr. 15min.)	73457

How to set up your VCR

Setting up your VCR involves coordinating the TV channel number (the number you turn to on your TV or VCR to watch a program) with the guide channel (the number that's assigned to that channel in your program guide). To get the guide channel numbers, find the "Channel Line-up Chart" in the program guide for your area that features VCR PlusCodes. It usually looks like the example to the right.

Example of "Channel Line-up Chart"

CABLE CH	CABLE TV	VCR Plus+ GUIDE CH
16	AMC American Movie Classics	25
17	Bravo (program grid only)	54
20	Cable News Network	42
21	C-SPAN	28
22	The Disney Channel	53
25	The Discovery Channel	37
34	ESPN	34
35	The Family Channel	47
5	Home Box Office	33
27	Lifetime	46
29	Comix	45
30	Music Television	48
31	Nickelodeon	38
38	Sports Channel	59
39	Sports Channel America	70
45	Showtime	41
17	TBS SuperStation	43
44	The Movie Channel	58
49	The Nashville Network	49
50	Turner Network Television	52
51	USA USA Network	44

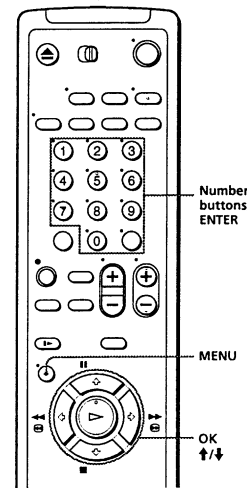

1 Press MENU, then press **↑/↓** to move the cursor (▶) to SET VCR PLUS+ CHANNELS and press OK.

SET VCR PLUS+ CHANNELS

GUIDE CH TV CH

7 4 - -

PUSH 0-9 KEYS TO SET PROGRAM GUIDE CH

OR PUSH OK TO SEE VCR PLUS+ CHANNEL LIST

2 Enter the channel number assigned in the program guide and press ENTER.

SET VCR PLUS+ CHANNELS

GUIDE CH TV CH

7 4 - -

PUSH 0-9 KEYS TO SET PROGRAM GUIDE CH

THEN PUSH ENTER

continued

Setting up VCR Plus+ (continued)

- 3**
- If you made Hookup 1, 2, or 3: Enter the actual number on your TV (and VCR) and press ENTER.
 - If you made Hookup 4: Enter the cable output channel (usually 2, 3 or 4) and press ENTER.
 - If you made Hookup 6: Enter the actual number on your TV (and VCR) for an unscrambled channel and press ENTER. For a scrambled channel, enter the cable box output channel (usually 2, 3 or 4) and press ENTER.

SET VCR PLUS+ CHANNELS
GUIDE CH TV CH
33 - 73 59 - 47
PUSH 0-9 KEYS TO SET PROGRAM TV CH
THEN PUSH ENTER

SET VCR PLUS+ CHANNELS
GUIDE CH TV CH
33 - 73 59 - 47
PUSH 0-9 KEYS TO SET PROGRAM TV CH
THEN PUSH ENTER

- 4** Repeat steps 2 and 3 for each channel whose numbers don't match.

- 5** When you have set all channels, press OK to confirm your channel settings.



VCR PLUS+ CHANNEL LIST
PAGE 1
GUIDE TV GUIDE TV
2 - 73 59 - 47
5 - 4 61 - 3
17 - 56 77 - 35
28 - 9 85 - 120
33 - 5 90 - 22
USE <LEFT> TO CHANGE PAGE
PUSH MENU TO QUIT

- 6** When you've finished, press MENU to exit.



Basic Operations

Playing a tape

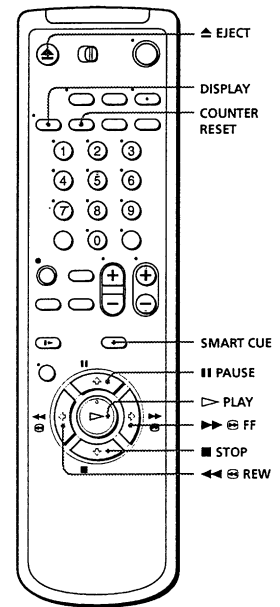

- 1** Turn on your TV and set it to the video channel.

- 2** Insert a tape.
The VCR turns on and starts playing automatically if you insert a tape with its safety tab removed.

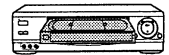

continued

Playing a tape (continued)

- 3** Press \triangleright PLAY.
When the tape reaches the end, it will rewind automatically.



Additional tasks

To	Press
Stop play	■ STOP
Pause play	PAUSE
Resume play after pause	PAUSE or \triangleright PLAY
Fast-forward the tape	$\triangleright\triangleright$ FF during stop
Rewind the tape	$\triangleleft\triangleleft$ REW during stop
Eject the tape	\blacktriangle EJECT

To skip playback

You can skip a portion of playback you don't want to watch such as a commercial and restart playback by pressing a single button.
Press SMART CUE during playback of the scene you want to skip. The VCR starts searching.

Press SMART CUE again when you find the scene you want to watch. The VCR stops searching, rewinds a few seconds, then resumes normal playback.

To use the time counter

At the point on the tape that you want to find later, press COUNTER RESET. The counter in the display window resets to "0:00:00." Search for the point afterwards by referring to the counter.

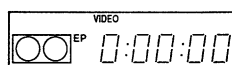

To display the counter on the TV screen, press DISPLAY repeatedly.

Notes

- Tapes recorded in the LP mode on other VCRs can be played back on this VCR but the picture quality cannot be guaranteed.
- While setting the menu on the TV screen, you cannot use the \triangleright PLAY, || PAUSE, $\triangleright\triangleright$ FF, $\triangleleft\triangleleft$ REW, or ■ STOP buttons.
- The counter resets to "0:00:00" whenever a tape is reinserted.
- The counter stops counting when it comes to a portion with no recording.

Recording TV programs

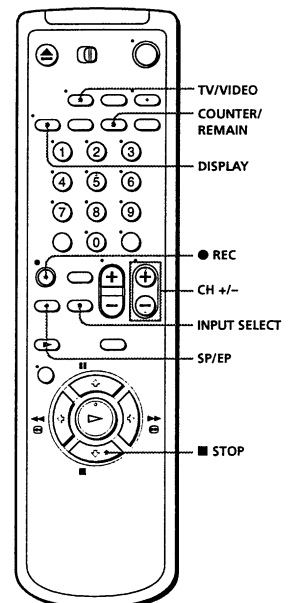

- 1** Turn on your TV and set it to the video channel.
To record from a cable box, turn it on.

- 2** Insert a tape with its safety tab in place.

continued

Recording TV programs (continued)

- 3**  Press INPUT SELECT until a channel number appears in the display window.

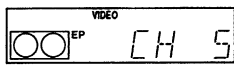

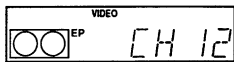

- 4**  Press CH +/- to select the channel you want to record.

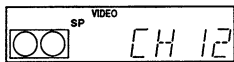

- 5**  Press SP/EP to select the tape speed, SP or EP. EP (Extra Play) provides recording time three times as long as SP (Standard Play), however, SP produces better picture and audio quality.



- 6**  Press  to start recording. The recording indicator lights up red in the display window.

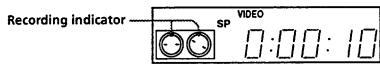

To stop recording
Press .

To check the remaining time

Press DISPLAY repeatedly until the time counter appears on the TV screen. With the display on, press COUNTER/REMAIN to check the remaining time. Each time you press COUNTER/REMAIN, the time counter and the remaining time appear alternately. The  indicator also appears in the display window.



To check the remaining time of a T-140 or T-180 tape, set TAPE SELECT in the ADVANCED OPTIONS menu to "180." (For details, see page 66.)

To watch another TV program while recording

- 1 Press TV/VIDEO to turn off the VIDEO indicator in the display window.
- 2 If the TV is connected to the VCR's LINE OUT jacks, set the TV to TV input; if not, skip this step.
- 3 Select another channel on the TV.

To save a recording

To prevent accidental erasure, break off the safety tab as illustrated. To record on a tape again, cover the tab hole with adhesive tape.



Safety tab

continued

Recording TV programs (continued)

Tips

- To select a channel, you can use the number buttons on the remote commander. Enter the channel number, then press ENTER.
- You can select a video source from the LINE-1 IN or LINE-2 IN jacks using the INPUT SELECT button.
- The display appears on the TV screen indicating information about the tape, but the information won't be recorded on the tape.
- If you don't want to watch TV while recording, you can turn off the TV. When using a cable box, make sure to leave it on.

Notes

- The remaining time may not be indicated accurately for:
 - short tapes less than T-20
 - T-130
 - T-210
 - tapes recorded in the LP mode.
- The display doesn't appear during still (pause) mode, search mode or slow-motion playback.
- It may take up to one minute for the VCR to calculate and display the remaining time after you press DISPLAY.

Recording TV programs using VCR Plus+

Just enter the program's PlusCode listed in the TV program guide. The date, times and channel number of that program are set automatically. You can preset up to eight programs at a time.

Before you start...

- Check that the VCR clock is set to the correct time.
- Turn on your TV and set it to the video channel. When using a cable box, turn it on.
- Insert a tape with its safety tab in place. Make sure the tape is longer than the total recording time.

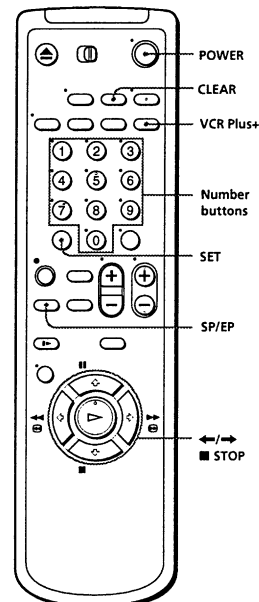

- 1**  Press VCR Plus+.

VCR PLUS+
PLUSCODE SP / EP

ENTER PROGRAM'S PLUSCODE
USING 0-9 KEYS
TO CHANGE TAPE SPEED
PUSH SP/EP

continued

Recording TV programs using VCR Plus+ (continued)

- 2**  Press the number buttons to enter the program's PlusCode.
If you make a mistake, press CLEAR and re-enter the correct number.

VCR PLUS+		
PLUSCODE	SP/EP	
8912----	SP	
USE \leftarrow/\rightarrow KEYS FOR:		
• ONCE	DAILY	WEEKLY
TO CONFIRM	: SET	
TO CANCEL	: CLEAR	
- 3**  Press SP/EP to select SP or EP.

VCR PLUS+		
PLUSCODE	SP/EP	
8912----	SP	
USE \leftarrow/\rightarrow KEYS FOR:		
• ONCE	DAILY	WEEKLY
TO CONFIRM	: SET	
TO CANCEL	: CLEAR	
- 4**  Press \leftarrow/\rightarrow to select ONCE, DAILY, or WEEKLY, then press SET:

To record	Select
Only once	ONCE
Everyday Monday to Friday	DAILY
Once a week	WEEKLY

The date, start and stop times, channel number, and tape speed appear on the TV screen. If the information is not correct, press CLEAR to cancel the setting.

VCR PLUS+			
PLUSCODE	SP/EP		
8912----	SP		
RECORDING TIME			
DATE	START	STOP	CH
11/17	TU	11:00W	11:00W 60SP
TO SET TIMER: PUSH POWER			
TO CANCEL : PUSH CLEAR			
- 5** To enter another setting, repeat steps 1 to 4.
- 6**  Press POWER to turn off the VCR.
The \odot indicator appears in the display window and the VCR stands by for recording. When using a cable box, leave it on.

To stop recording
To stop the VCR while recording, press \blacksquare STOP.

To use the VCR after setting the timer

To use the VCR before a timer recording begins, just press POWER. The \odot indicator turns off and the VCR switches on. Remember to press POWER to reset the VCR in timer recording standby after using the VCR.

You can also do the following tasks while the VCR is recording:

- Reset the counter.
- Display tape information on the TV screen.
- Check the timer settings.
- Watch another TV program.

To lock the VCR after setting the timer (Child Lock)

While the VCR turns on, hold POWER down on the VCR until "LOC" and the \odot indicator appear in the display window. The VCR turns off and the \odot indicator remains lit. The VCR will not work except for timer recording.

To unlock the VCR, hold POWER down on the VCR until the \odot indicator disappears from the display window. The VCR is unlocked and turns on.

To stop timer recording while the VCR is locked, press \blacksquare STOP. The recording stops and the VCR is unlocked.

Tip

- To cancel the procedure, press VCR Plus+ before pressing SET.

Note

- If the VCR doesn't accept the PlusCode, this means that:
 - The PlusCode is incorrect.
 - ONCE, DAILY or WEEKLY was selected incorrectly. You cannot select DAILY or WEEKLY for a program that airs more than seven days ahead.

Setting the timer manually

If VCR Plus+ is not available in your area, follow the instructions below to set the timer to record programs.

Before you start...

- Check that the VCR clock is set to the correct time.
- Turn on your TV and set it to the video channel. When using a cable box, turn it on.
- Insert a tape with its safety tab in place. Make sure the tape is longer than the total recording time.

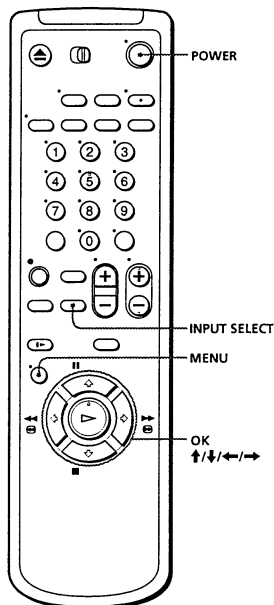

- 1**  Press MENU and select TIMER SET/CHECK, then press OK.

TIMER SET / CHECK		11 / 18	MO
DATE	START	STOP	CH
\rightarrow /---	---	---	---
\rightarrow /---	---	---	---
\rightarrow /---	---	---	---
\rightarrow /---	---	---	---
\rightarrow /---	---	---	---
\rightarrow /---	---	---	---
\rightarrow /---	---	---	---
\rightarrow /---	---	---	---

- 2** Set the date, start and stop times, channel number and tape speed:

 - 1 Press \rightarrow to flash each item in turn.
 - 2 Press \uparrow/\downarrow to set each item.

To correct a setting, press \leftarrow to return to that setting and reset.

To record the same program every day or the same day every week, press \downarrow while the date is flashing. For details, see "Daily/weekly recording" on this page.

To record from a source connected to the LINE-1 IN or LINE-2 IN jacks, press INPUT SELECT to display "L1" or "L2" in the "CH" position.

TIMER SET / CHECK	11 / 18	MO	
DATE	START	STOP	CH
\rightarrow /---	---	---	---
\rightarrow /---	---	---	---
\rightarrow /---	---	---	---
\rightarrow /---	---	---	---
\rightarrow /---	---	---	---
\rightarrow /---	---	---	---
\rightarrow /---	---	---	---
\rightarrow /---	---	---	---
- 3** Press \rightarrow to confirm the setting.
The cursor (\blacktriangleright) appears at the beginning of the line. To enter another setting, move the cursor to the next line and repeat step 2.
- 4** Press OK.
- 5**  Press POWER to turn off the VCR.
The \odot indicator appears in the display window and the VCR stands by for recording. When using a cable box, leave it on.

Daily/weekly recording

In step 2 above, press \downarrow to select the recording pattern. Each time you press \downarrow , the indication changes as shown below. Press \uparrow to change the indication in reverse order.

the current date \rightarrow SU-SA \rightarrow MO-SA \rightarrow MO-FR \rightarrow EVERY SA \rightarrow \rightarrow EVERY MO \rightarrow EVERY SU \rightarrow 1 month later \rightarrow (dates count down) \rightarrow the current date

Tips

- To set the channel, you can also use the CH+/- or number buttons.
- To set the tape speed, you can also use the SP/EP button.

Note

- If you are using cable box control, you cannot select "L1" or "L2".

Playing/searching at various speeds

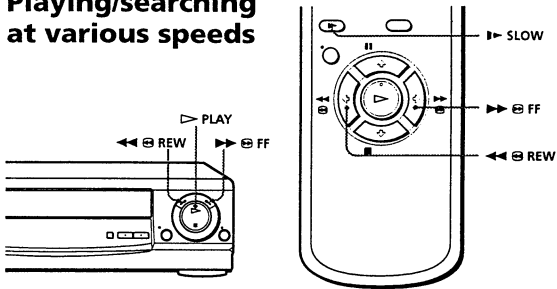

Playback options	Operation
View the picture during fast-forward or rewind	During fast-forward, hold ▶▶ FF down. During rewind, hold ◀◀ REW down.
Play at high speed	<ul style="list-style-type: none"> During playback, press ▶▶ FF or ◀◀ REW. During playback, hold ▶▶ FF or ◀◀ REW down. When you release the button, normal playback resumes.
Play in slow motion	During playback or pause, press ▶ SLOW .
Play frame by frame	During pause, press ▶▶ FF or ◀◀ REW . Hold the button down to play one frame each second.
Rewind and start play	During stop, press ▶▶ PLAY on the VCR while holding ◀◀ REW down on the VCR.

To resume normal playback

Press **▶▶ PLAY**.

Tips

- Adjust the picture using the TRACKING +/- buttons on the VCR if:
 - Streaks appear while playing in slow motion.
 - The picture shakes while pausing.
- To set tracking to the center position, press both buttons (+/-) at the same time.
- When you hold **▶▶ FF** or **◀◀ REW** down during stop, skip-search starts. For details, see page 59.

Notes

- The sound is muted during these operations.
- Tapes recorded in the LP mode on other VCRs can be played back on this VCR but the picture quality cannot be guaranteed.
- The picture may have snow when playing at high speed in reverse.

Searching for a selected point on the tape

You can easily find a selected point by moving the pointer on the TV screen. The VCR fast-forwards or rewinds to the point you indicate and starts playback automatically.

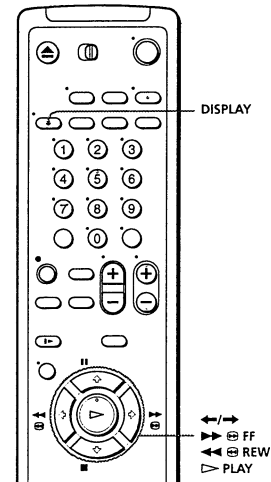

- Press **DISPLAY** repeatedly until the bar indication appears on the TV screen.
A cursor (■) indicating the current position of the tape appears on the bar indication. If the cursor does not appear, play the tape a few moments (by pressing **▶▶ PLAY**, **▶▶ FF** or **◀◀ REW**) until the cursor appears.
- Press **◀/▶** to move the pointer (+) to the point where you want to start playback.
The VCR starts searching and the cursor (■) moves toward the pointer. When the VCR locates the marked point, playback starts.

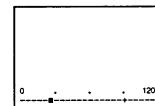
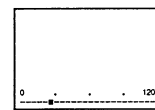

continued

Searching for a selected point on the tape (continued)

To cancel searching

Press **▶▶ PLAY** or **■ STOP**.

To turn off the bar indication

Press **DISPLAY** again.

Notes

- The figure on the bar indication represents the total time length of the inserted tape as shown below.
The total time length may not be displayed correctly for:
 - tapes other than T-60, T-120, or T-160
 - tapes recorded in more than one tape speed mode.

Tape type	Total time length		
	SP	LP	EP
T-60 or shorter	60	120	180
from T-80 to T-140	120	240	360
T-160 or longer	160	320	480

- If you move the pointer (+) on the bar indication during search, the VCR searches for the new reset point.
- While the cursor (■) is displayed on the bar indication, the **▶▶ FF/▶** and **◀◀ REW/◀** buttons on the remote commander work only for moving the pointer (+), while the **▶▶ FF** and **◀◀ REW** buttons on the VCR work for normal tape operation. Note, however, if you press these buttons on the VCR, searching is canceled.

Skip-searching automatically

You can spot check a whole tape quickly. At intervals, the VCR skips playback while searching forward or backward.

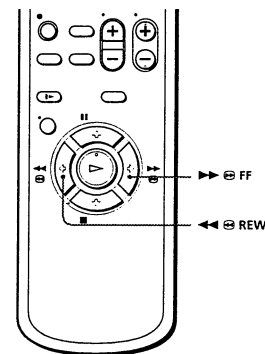

Hold **▶▶ FF** (or **◀◀ REW**) down more than two seconds during stop. "SKIP" appears on the TV screen.

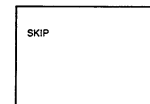

The VCR searches forward (or backward) for about two minutes on the counter, then fast-forwards (or rewinds) for about ten minutes on the counter. The VCR repeats this operation until it stops at the end (or beginning) of the tape.

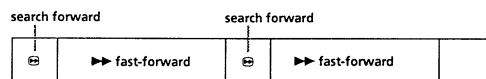

To cancel skip-search

Press **▶▶ PLAY** or **■ STOP**.

Note

- The VCR automatically fast-forwards (or rewinds) any portion with no recording.

Recording TV programs using the quick timer

After starting recording in the normal way, you can have the VCR stop recording automatically after a specified duration.

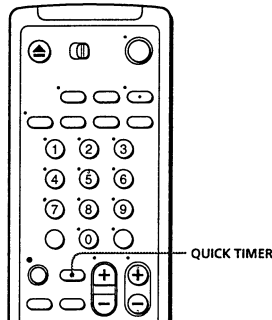

- 1 While recording, press QUICK TIMER once.

The \odot indicator appears in the display window.

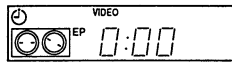

- 2 Press QUICK TIMER repeatedly to set the duration. Each press advances the time in increments of 30 minutes.

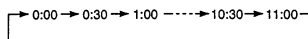

The duration decreases minute by minute to 0:00, then the VCR stops recording and turns off automatically.

To extend the duration

Press QUICK TIMER repeatedly to set to the new duration.

To stop the VCR while recording

Press \blacksquare STOP.

Using the quick timer during stop mode

You can set the quick timer and start recording during stop mode by pressing QUICK TIMER. To set the channel, you can use the CH +/- or INPUT SELECT buttons. Press QUICK TIMER repeatedly to set the recording duration. The recording will start automatically.

Checking/ changing/ canceling timer settings

Before you start...

- Turn on your TV and set it to the video channel.

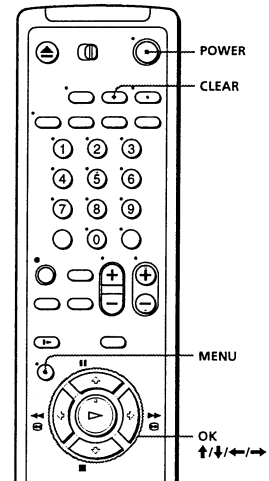

- 1 Press POWER to turn on the VCR.
- 2 Press MENU and select TIMER SET/CHECK:

- If you want to change a setting, go on to the next step.
- If you do not need to change the settings, press OK, then turn off the VCR to return to recording standby.

TIMER SET / CHECK	11 / 16	MO		
DATE	START	STOP	CH	
11/17	TU	7:00W	8:30W	6SP
11/25	WE	11:30W	11:15W	802P
MO - SA	1:00W	3:30W	1:15P	
EVERYSU	1:55W	1:30W	42P	
- / - / -	- / - / -	- / - / -	- / - / -	
- / - / -	- / - / -	- / - / -	- / - / -	
- / - / -	- / - / -	- / - / -	- / - / -	

- 3 Press \uparrow / \downarrow to select the setting you want to change or cancel:
 - To change the setting, press \leftarrow / \rightarrow to flash the item you want to change, and press \uparrow / \downarrow to reset it. Then, press \rightarrow repeatedly until the cursor (\blacktriangleright) appears at the beginning of the line.
 - To cancel the setting, press CLEAR.
- 4 Press OK.

If any timer settings remain, turn off the VCR to return to recording standby.

continued

Checking/changing/canceling timer settings (continued)

When the timer settings overlap

The program that starts first has priority and the second program starts recording only after the first program has finished. If the programs start at the same time, the program listed first in the menu has priority.

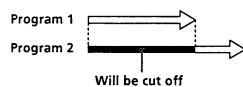

Recording stereo and bilingual programs

Recording stereo programs

This VCR automatically receives and records stereo programs. When a stereo program is received, the STEREO indicator lights up. If there is noise in the stereo program, set AUTO STEREO in the ADVANCED OPTIONS menu to OFF. The sound will be recorded in monaural (on both hi-fi and normal audio tracks) but with less noise. For details, see page 66.

Recording bilingual programs

Normally, this VCR records only the main sound. When a SAP (Second Audio Program) is received, the SAP indicator lights up. To record only SAP sound, set TUNER AUDIO in the ADVANCED OPTIONS menu to SAP. For details, see page 66.

Selecting the sound while playing

Press AUDIO MONITOR to select the desired sound. (The sound being recorded will not change.)

Stereo program

To listen to	Indicator on the TV screen
Stereo	STEREO
Left channel	L
Right channel	R
Monaural sound on the normal audio track*	No indicator appears

* Usually the mixed sound of left and right channels

continued

How sound is recorded on a video tape

The VCR records sound onto two separate tracks. Hi-fi audio is recorded onto the main track along with the picture. Monaural sound is recorded onto the normal audio track along the edge of the tape.

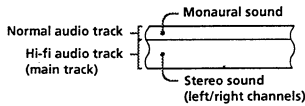

Notes

- To play a tape in stereo, you must use the A/V connections.
- When you play a tape recorded in monaural, the sound is heard in monaural regardless of the AUDIO MONITOR setting.

Adjusting the picture

Adjusting the tracking

Although the VCR automatically adjusts the tracking when playing a tape (the indicator flashes in the display window, then goes off), distortion may occur if the tape was recorded in poor condition. In this case, manually adjust the tracking.

Press the TRACKING +/- buttons on the VCR to display the tracking meter. The distortion should disappear as you press one of the two buttons (the indicator lights up). To resume automatic tracking adjustment, eject the tape and reinsert it.

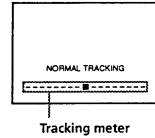

About Adaptive Picture Control (APC)

Adaptive Picture Control (APC) automatically improves recording and playback quality by adjusting the VCR to the condition of the video heads and tape. To maintain better picture quality, we recommend that you set APC to ON in the ADVANCED OPTIONS menu (with the APC indicator in the display window lit).

APC playback

The APC function automatically works on all types of tapes, including rental tapes and tapes that were not recorded with APC.

APC recording

Whenever you insert a tape and first start recording, the VCR adjusts to the tape using the APC function (the APC indicator flashes rapidly). This adjustment is retained until the tape is ejected.

Notes

- The auto tracking adjustment cannot be guaranteed to work with tapes recorded in LP mode on other VCRs.
- With the Auto Tape Speed function on, the APC function doesn't work if the tape speed is automatically changed from the SP to EP mode during a timer recording, unless the tape has been recorded in the EP mode with the APC function. For details, see page 66.
- There is a delay of a few seconds before the VCR actually starts recording while the VCR analyzes the tape. To avoid the delay, first set the VCR to recording pause (the APC indicator flashes slowly) and press to have the VCR analyze the tape. After the APC indicator stops flashing, press to start recording immediately. If you press before the APC indicator stops flashing, the APC function is canceled.

Changing menu options

- 1 Press MENU and select ADVANCED OPTIONS.

ADVANCED OPTIONS			
▶AUTO STEREO	•ON	OFF	
TUNER AUDIO	•MAIN	SAP	
APC	•ON	OFF	
TAPE SELECT	•AUTO	180	
AUTO TAPE SPEED	•ON	OFF	
SHARPNESS	L	M	H

- 2 Press to select the option to change, then press to change the setting.
- 3 Press OK to return to the original screen.

Menu choices

Initial settings are indicated in bold print.

Menu option	Set this option to
AUTO STEREO	ON to receive stereo programs. OFF to reduce noise; the sound changes to monaural.
TUNER AUDIO	MAIN to record the main sound. SAP to record the SAP (Second Audio Program) sound.
APC	ON to switch on the APC (Adaptive Picture Control) function and improve picture quality. OFF to switch off APC.
TAPE SELECT	AUTO or 180 (when using a T-140 or T-180 tape) to operate AUTO TAPE SPEED correctly.
AUTO TAPE SPEED	ON to change the timer recording tape speed automatically to the EP mode when the remaining tape becomes shorter than the recording time. OFF to keep the set tape speed.
SHARPNESS	L (Low) through H (High) to adjust the sharpness of the picture. L to turn off the sharpness control.

Editing with another VCR

How to hook up to record on this VCR

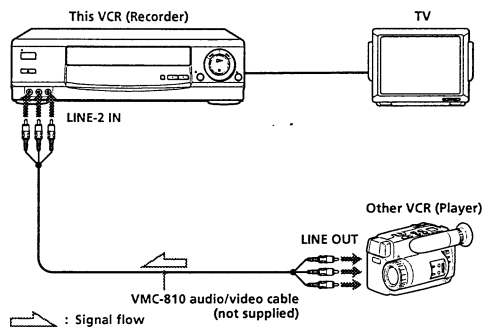

How to hook up to a stereo system

Connect LINE-2 IN AUDIO on this VCR to the audio output jacks on the stereo system, using the RK-C510KS audio cable (not supplied).

Notes

- Make sure you connect the plugs to jacks of the same color.
- If the other VCR is a monaural type and connected to this VCR's LINE-2 IN jacks, connect the audio plug to the AUDIO L (white) jack. The sound is recorded on both right and left channels. When connecting to the AUDIO R (red) jack, the sound is recorded only on the right channel.
- If you connected this VCR to both the LINE IN and LINE OUT jacks of the other VCR, select the input correctly to prevent a humming noise.
- You can also use the LINE-1 IN jacks instead. If the other VCR is a monaural type, the sound is recorded only on the channel whose jack is connected to the audio plug. To record on both right and left channels, connect the audio plugs to the AUDIO R/L jacks using a VMC-910MS audio/video cable (not supplied).

continued

Operation (when recording on this VCR)

Before you start editing

- Turn on your TV and set it to the video channel.
- Press INPUT SELECT on the remote commander to display "L1" or "L2" in the display window.
- Press SP/EP on the remote commander to select the tape speed, SP or EP.

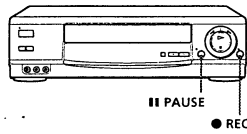

- 1 Insert a source tape with its safety tab removed into the other (playback) VCR. Search for the point to start playback and set it to playback pause.
- 2 Insert a tape with its safety tab in place into this (recording) VCR. Search for the point to start recording and press PAUSE.
- 3 Press REC on this VCR and set it to recording pause.
- 4 To start editing, press the PAUSE buttons on both VCRs at the same time.

To stop editing

Press the STOP buttons on both VCRs.

Note

- If you start recording following the procedure above, the VCR won't start recording with the APC function. To record a tape with the APC function, press REC again during recording pause in step 3 so that the VCR analyzes the tape. Then when you start recording in step 4, press PAUSE immediately after the APC indicator stops flashing. If you press PAUSE before the APC indicator stops flashing, the APC function is canceled.

General setup information

Setting the RF unit

When connecting the VCR to the TV using only the antenna cable, you must set the RF UNIT switch on the rear of the VCR so that the TV can receive the correct signal from the VCR.

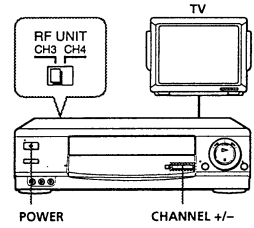

- 1 Set the RF UNIT switch on the rear of the VCR to CH 3 or CH 4, whichever channel is not used in your area. If both are used, set the switch to either channel.
- 2 Press POWER to turn on the VCR.
- 3 Press TV/VIDEO on the remote commander to turn on the VIDEO indicator in the VCR's display window.
- 4 Press CHANNEL +/- to display a channel number in the display window. Select an active channel number in your area.
- 5 Turn on your TV and set it to the channel you selected in step 1 (channel 3 or 4).
The selected TV channel broadcast appears on the TV screen. If the channels change when you press CHANNEL +/-, you have made the correct setting.
Whenever you use the VCR, set the TV to the channel selected in step 1.

continued

General setup information (continued)

Attaching the external antenna connector

When using a 300-ohm twin lead cable for a VHF/UHF antenna, use the EAC-32 antenna connector (not supplied) to connect the antenna to the VCR.

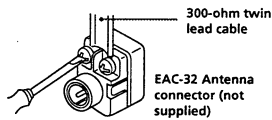

- 1 Loosen the screws on the antenna connector.
- 2 Wind the twin leads around the screws on the antenna connector.
- 3 Retighten the screws.

Attaching a UHF/VHF band mixer

When using both a 75-ohm coaxial cable and a 300-ohm twin lead cable for a VHF/UHF antenna, use the EAC-66 UHF/VHF band separator/mixer (not supplied) to connect the antenna to the VCR.

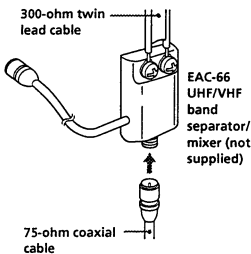

- 1 Loosen the screws on the mixer.
- 2 Wind the twin leads around the screws on the mixer.
- 3 Retighten the screws.
- 4 Connect the 75-ohm coaxial cable to the mixer.

Troubleshooting

If you have any questions or problems not covered below, please consult your nearest Sony dealer.

	Symptom	Remedy
Power	The POWER switch does not function.	<ul style="list-style-type: none"> • Connect the AC power cord securely. • Make sure the VCR is not locked. To unlock, hold POWER down on the VCR until the indicator disappears.
Clock	The clock has stopped and "--:--" lights in the display window.	<ul style="list-style-type: none"> • The clock stops if the VCR is disconnected from the wall outlet for more than one hour. Reset the clock (and timer).
	The playback picture does not appear on the TV screen.	<ul style="list-style-type: none"> • Make sure the TV is set to the channel for the VCR. If you are using a monitor, set it to video input.
Playback	The picture is not clear.	<ul style="list-style-type: none"> • Adjust the tracking with the TRACKING +/- buttons. • The video heads are dirty (see below). Clean the video heads using the Sony T-25CLD, T-25CLDR, or T-25CLW video head cleaning cassette. If these cleaning cassettes are not available in your area, have the heads cleaned at your nearest Sony service facility (a standard service charge will be required). Do not use a liquid-type cleaning cassette other than Sony's, as it may damage the video heads. • The video heads may have to be replaced. Consult your local Sony dealer for more information.
	The picture rolls vertically during picture search.	<ul style="list-style-type: none"> • Adjust the vertical hold control on the TV or monitor.
	The picture has no sound.	<ul style="list-style-type: none"> • The tape is defective. Use a new tape.

Symptoms caused by contaminated video heads

• Normal picture	• Rough picture	• Unclear picture	• No picture (or black & white screen appears)
	initial contamination		terminal

continued

Troubleshooting (continued)

Symptom	Remedy
A TV program does not appear on the TV screen.	• Make sure the TV is set to the channel for the VCR. If you are using a monitor, set it to video input.
TV reception is poor.	• Adjust the TV antenna.
The tape starts playing as soon as it is inserted.	• The safety tab has been removed. To record on this tape, cover the tab hole.
The tape ejects when you press ● REC.	• Check that the safety tab has not been removed.
Nothing happens when you press ● REC.	• Make sure the tape is not at its end. • Select the correct source. Select a channel number with the CH +/- buttons when recording TV programs; select "L1" or "L2" with the INPUT SELECT button when recording from other equipment.
The timer does not operate.	• Check that the clock is set. • Make sure a tape has been inserted. • Check that the safety tab has not been removed. • Make sure the tape is not at its end. • Make sure a program has been set for timer recording. • Make sure your timer settings have not already passed the current time. • Check that the cable box is turned on. • The clock stops if the VCR is disconnected from the wall outlet for more than one hour. Reset the clock and timer.
A tape cannot be inserted.	• Check that a tape isn't already in the tape compartment.
The remote commander does not function.	• Make sure you are pointing the remote commander at the remote sensor on the VCR. • Replace all the batteries in the remote commander with new ones if they are weak. • Make sure the [TV] / [VIDEO] remote control switch is set correctly.
The tracking meter does not appear on the screen.	• The recording condition of the tape is very poor and tracking cannot be adjusted.
You cannot control other TVs.	• Set your TV's code number. The code number resets to 01 when you replace the batteries of the remote commander.
The VCR needs to be cleaned.	• Clean the cabinet, panel and controls with a dry, soft cloth, or a soft cloth slightly moistened with a mild detergent solution. Do not use any type of solvent, such as alcohol or benzine.

Index to parts and controls

Refer to the pages indicated in parentheses () for details.

Front panel

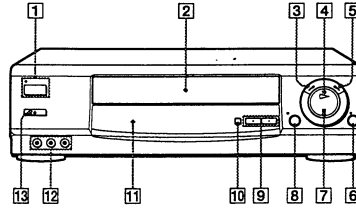

- | | |
|--|--|
| 1 POWER switch/indicator (52) | 9 CHANNEL/TRACKING +/- buttons (48, 65) |
| 2 Tape compartment | 10 EASY SET UP button (11, 14, 17, 20, 23, 25) |
| 3 ◀ REW (rewind) button (46, 56) | 11 Remote sensor (5) |
| 4 ▶ PLAY button (46) | 12 LINE-2 IN VIDEO/AUDIO L/R jacks (67) |
| 5 ▶▶ FF (fast-forward) button (46, 56) | 13 ▲ EJECT button (46) |
| 6 ● REC (record) button (48) | |
| 7 ■ STOP button (46) | |
| 8 PAUSE button (46) | |

72 | Additional Information

74 | Additional Information

Display window

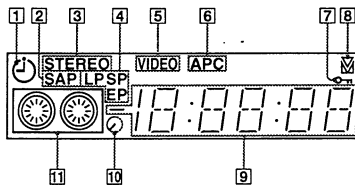

- | | |
|---|--|
| 1 Timer indicator (52) | 7 Child Lock indicator (53) |
| 2 SAP (Second Audio Program) indicator (63) | 8 Tracking indicator (65) |
| 3 STEREO indicator (63) | 9 Time counter/clock/line/channel indicator (46, 48, 68) |
| 4 Tape speed indicator (48) | 10 Remaining time indicator (49) |
| 5 VIDEO indicator (49, 69) | 11 Tape/recording indicator (48) |
| 6 APC (Adaptive Picture Control) indicator (65) | |

continued

Index to parts and controls (continued)

Rear panel

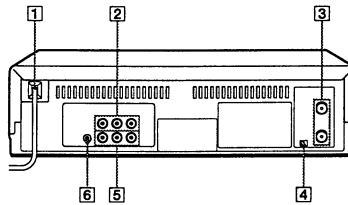

- | | |
|--|---|
| 1 AC power cord (7) | 4 RF (Radio Frequency) UNIT switch (69) |
| 2 LINE-1 IN AUDIO R/L/VIDEO jacks (22, 67) | 5 LINE OUT AUDIO R/L/VIDEO jacks (8) |
| 3 VHF/UHF IN/OUT connectors (10, 13, 16, 19, 22, 24) | 6 CABLE BOX CONTROL (CTRLS OUT) jack (10, 22) |

Additional Information | 75

76 | Additional Information

Remote commander

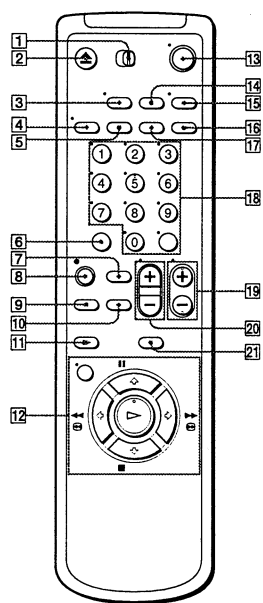

- 1 TV/VIDEO remote control switch (5)
- 2 EJECT button (46)
- 3 TV/VIDEO button (49, 69)
- 4 DISPLAY button (49, 57)
- 5 COUNTER RESET button (46)
- 6 SET button (52)
- 7 QUICK TIMER button (60)
- 8 REC (record) button (48)
- 9 SP (Standard Play)/EP (Extra Play) button (48)
- 10 INPUT SELECT button (48, 50)
- 11 SLOW button (56)
- 12 Tape/menu operation buttons
 - MENU button (28, 66)
 - PAUSE/↑ button (46)
 - STOP/↓ button (46)
 - REW (rewind)/← button (46, 56)
 - FF (fast-forward)/→ button (46, 56)
 - PLAY/OK button (46)
- 13 POWER switch (52)
- 14 CLEAR button (61)
- 15 AUDIO MONITOR button (63)
- 16 VCR Plus+ button (51)
- 17 COUNTER/REMAIN button (49)
- 18 Number buttons and ENTER button (43, 52)
- 19 CH (channel) +/- buttons (48)
- 20 VOL (volume) +/- buttons (6)
- 21 SMART CUE button (46)

SECTION 2 DISASSEMBLY

NOTE : Follow the disassembly procedure in the numerical order given.

2-1. UPPER CASE, FRONT PANEL BLOCK ASSEMBLY

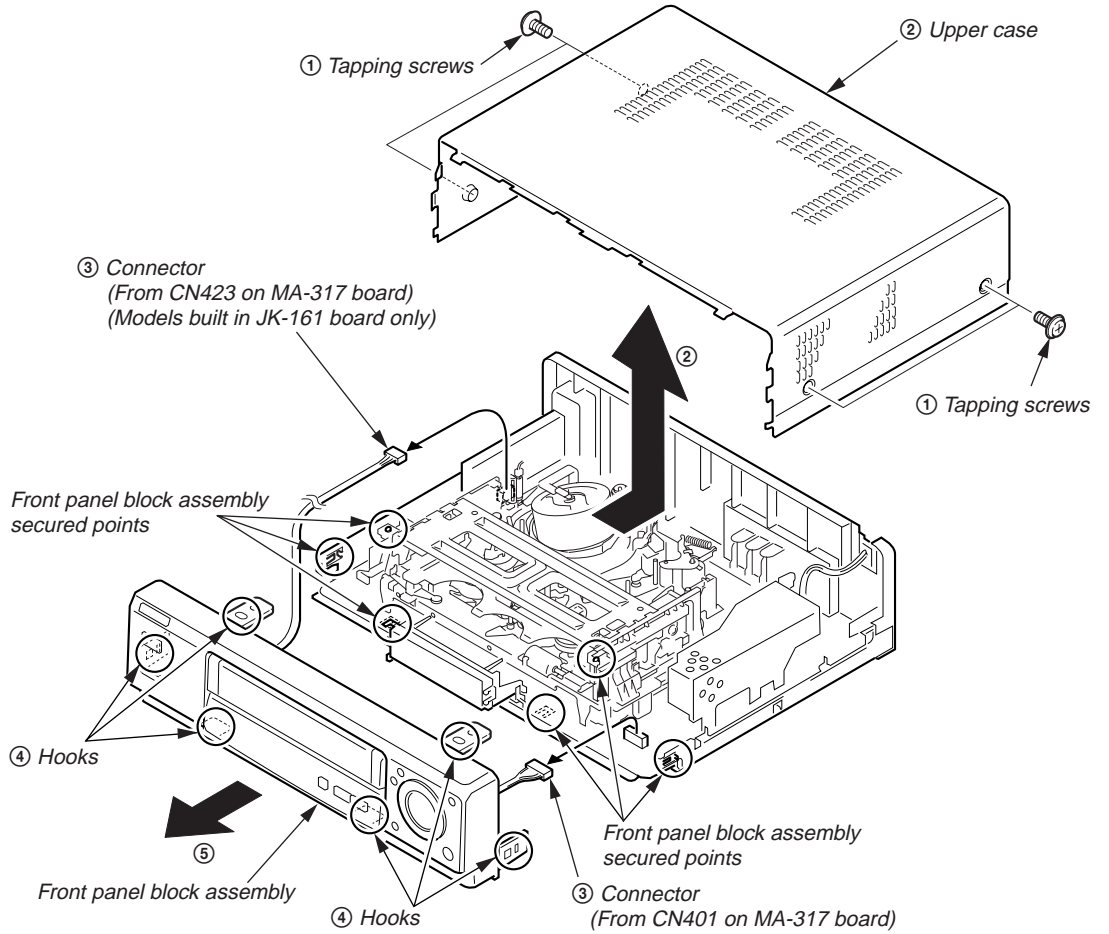

2-2. DS-79 BOARD, JK-161 BOARD

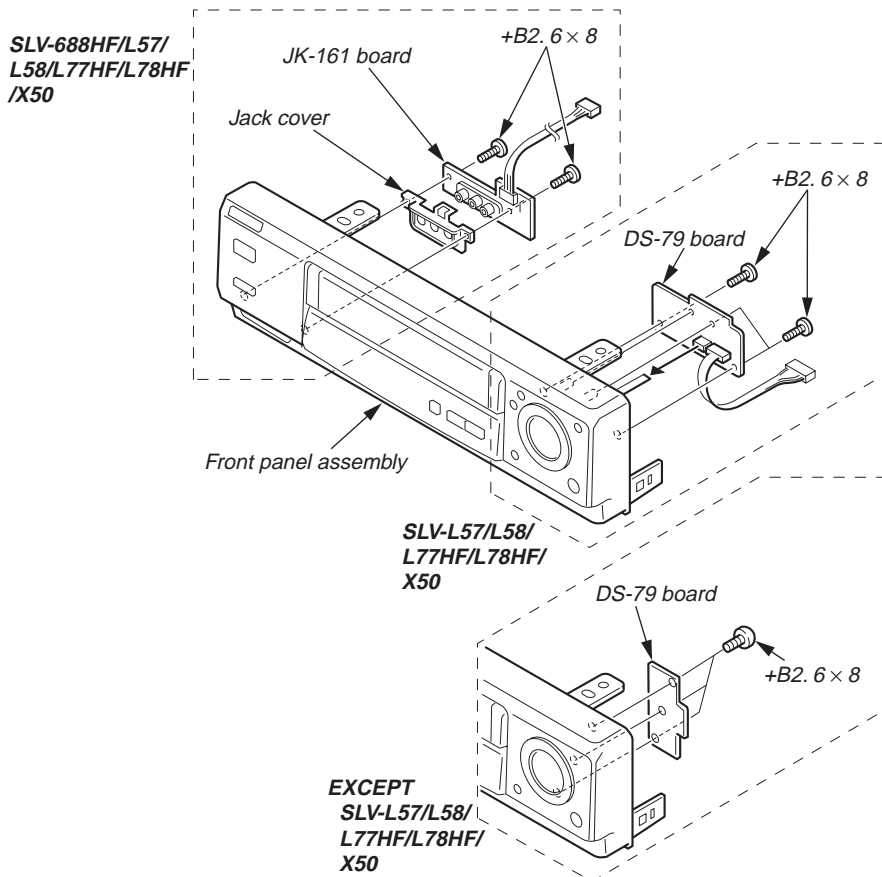

2-3. REAR PANEL

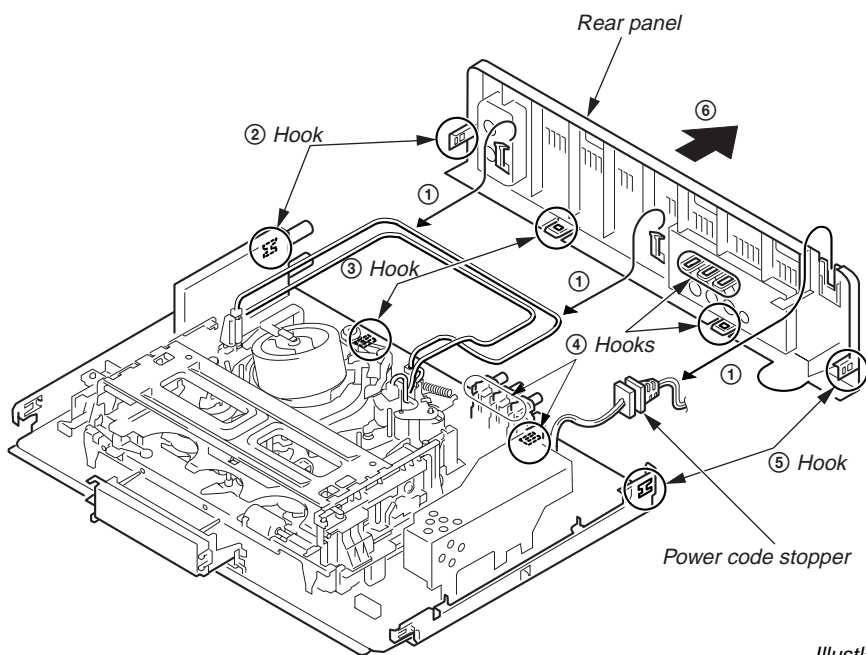
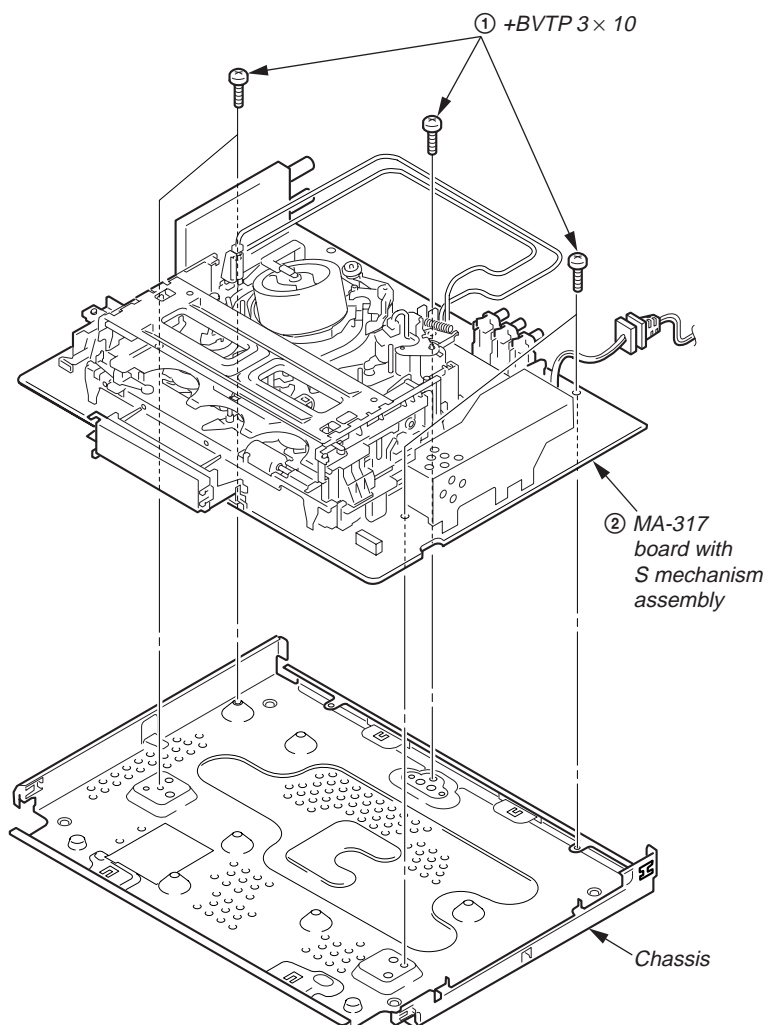
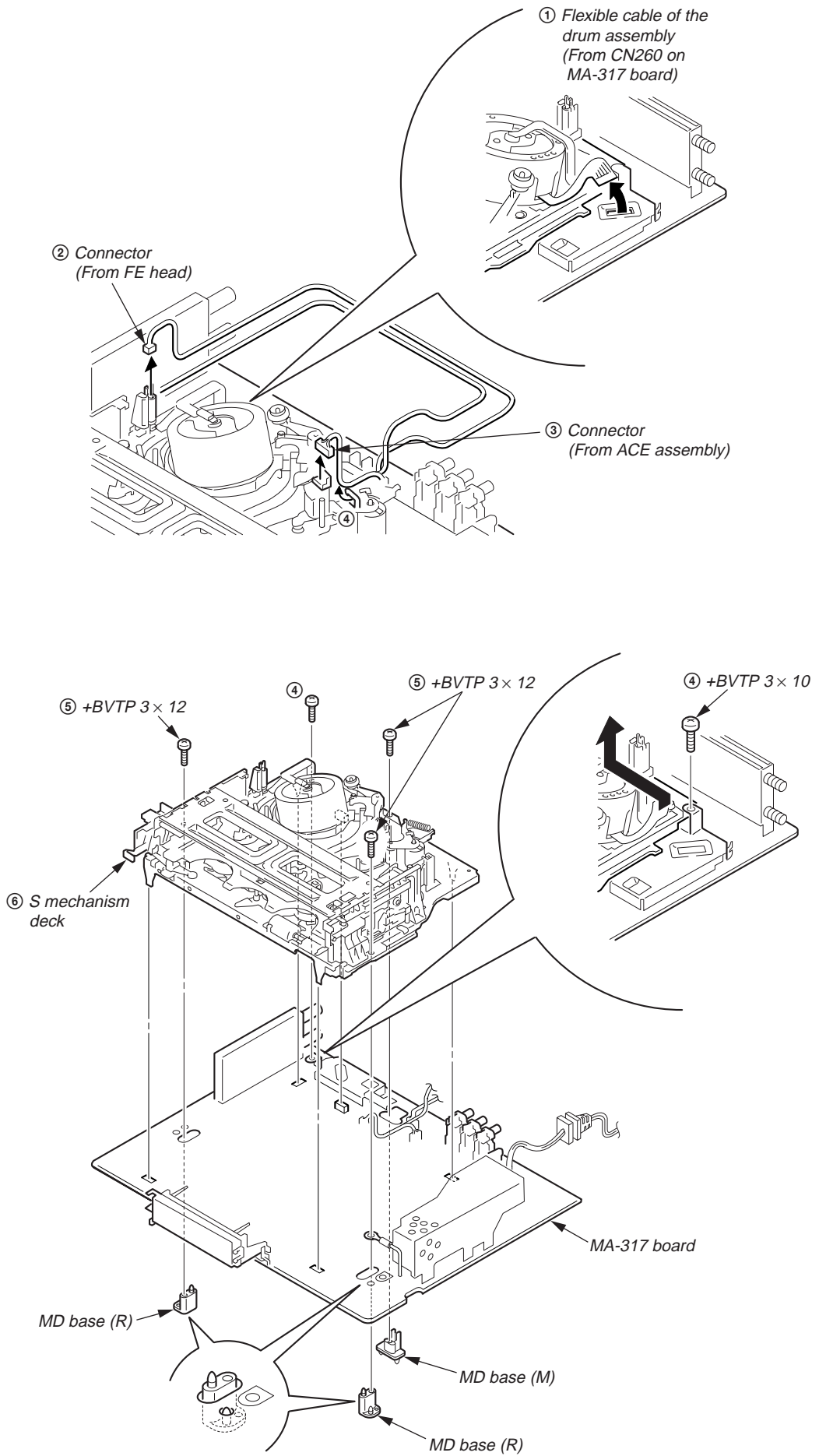

Illustration : HiFi model

2-4. MA-317 BOARD WITH S MECHANISM DECK ASSEMBLY



2-5. S MECHANISM DECK ASSEMBLY, MA-317 BOARD



2-6. INTERNAL VIEWS

—Top View—

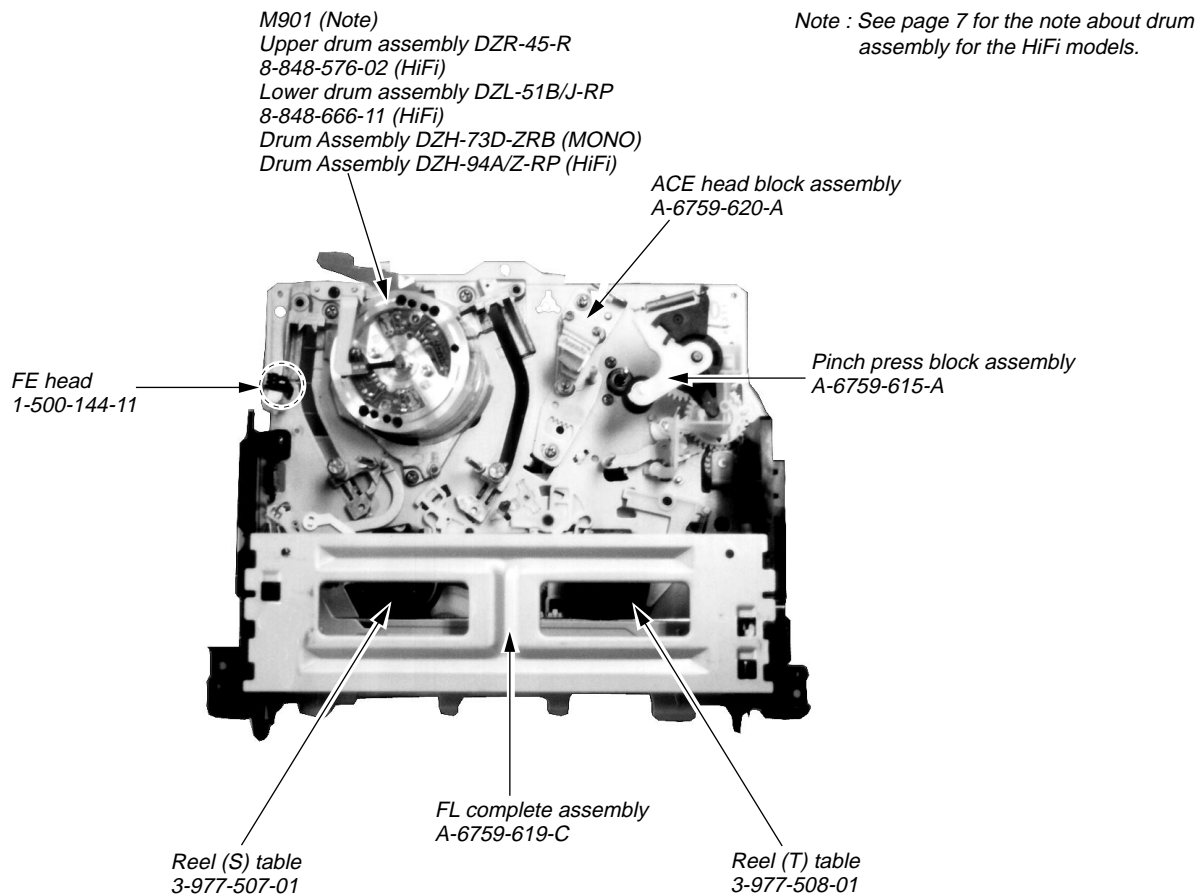

—Bottom View—

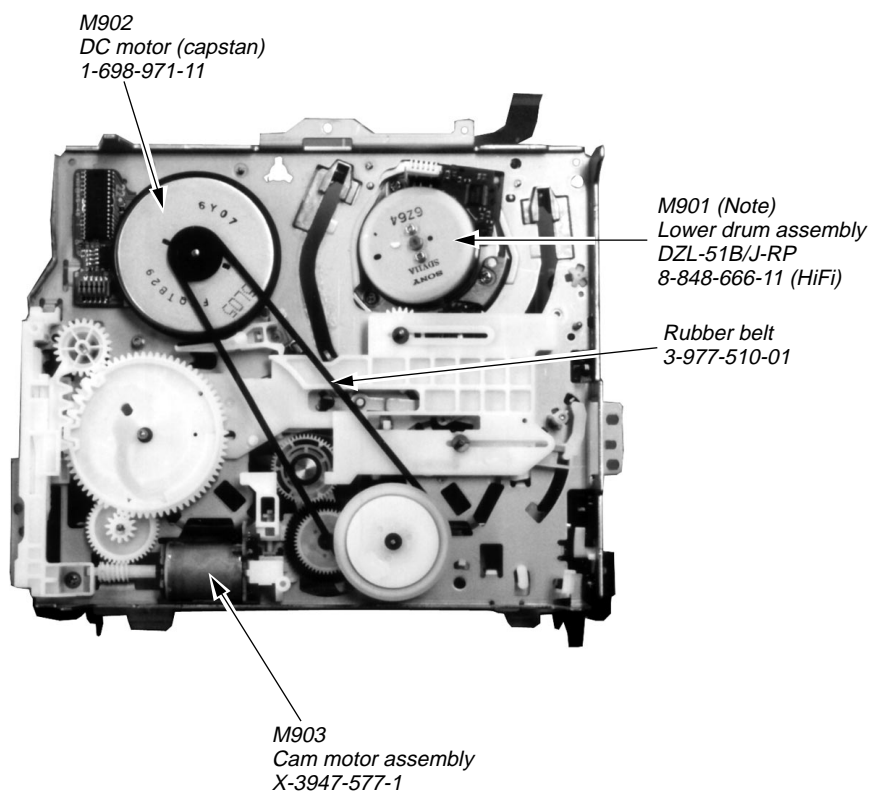

2-7. CIRCUIT BOARDS LOCATION

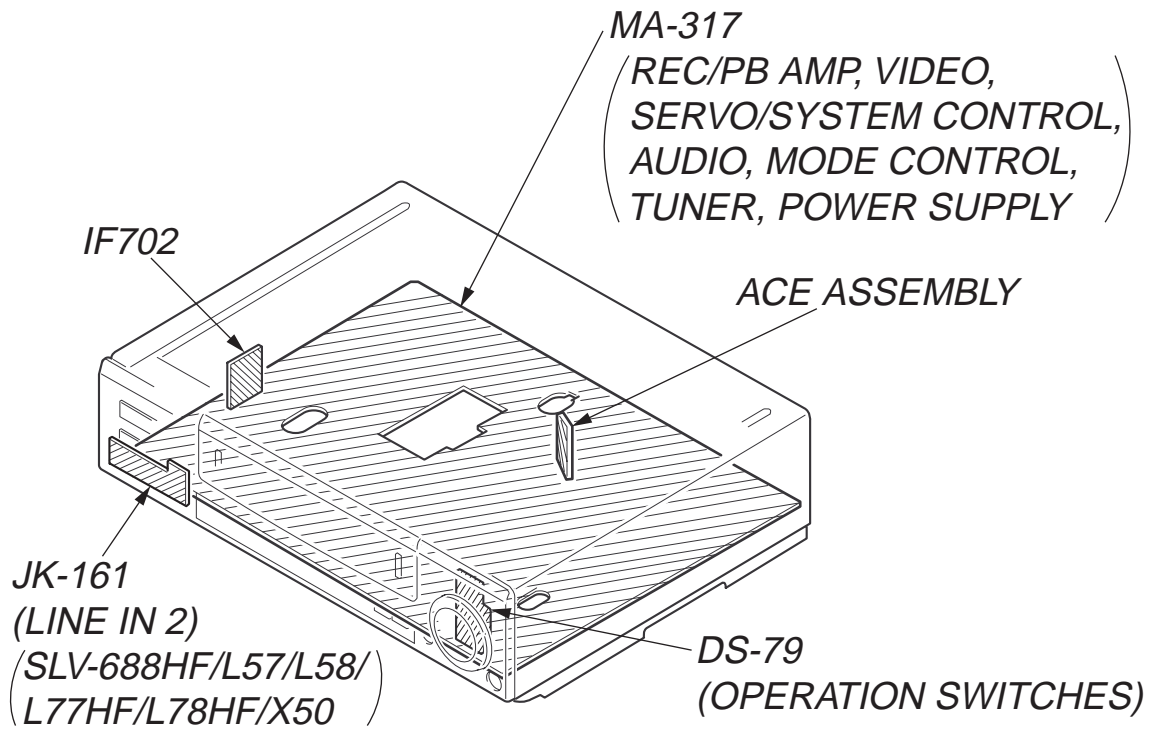

SECTION
BLOCK DIAGRAMS

3-1. OVERALL BLOCK DIAGRAM

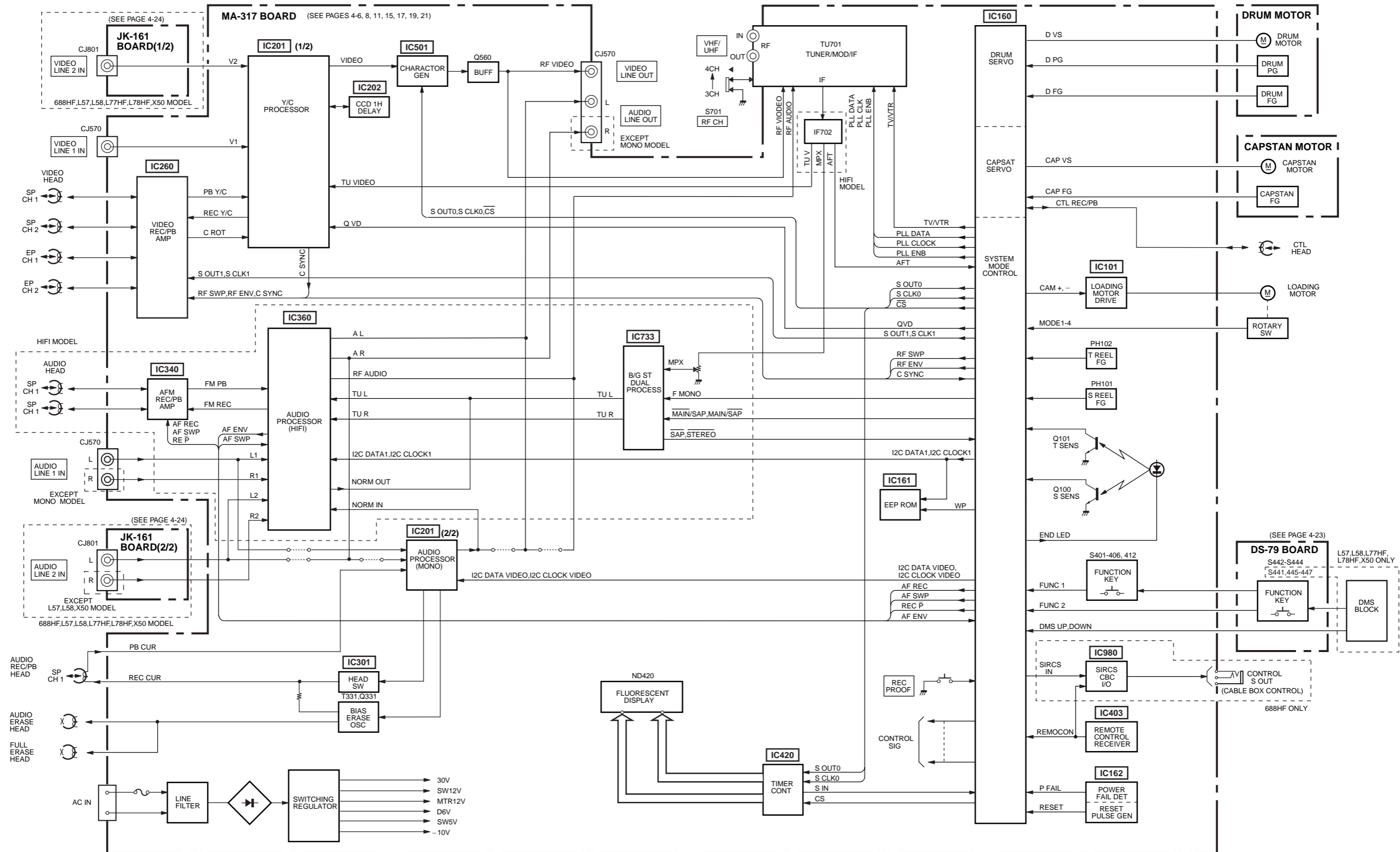

3-2. VIDEO BLOCK DIAGRAM

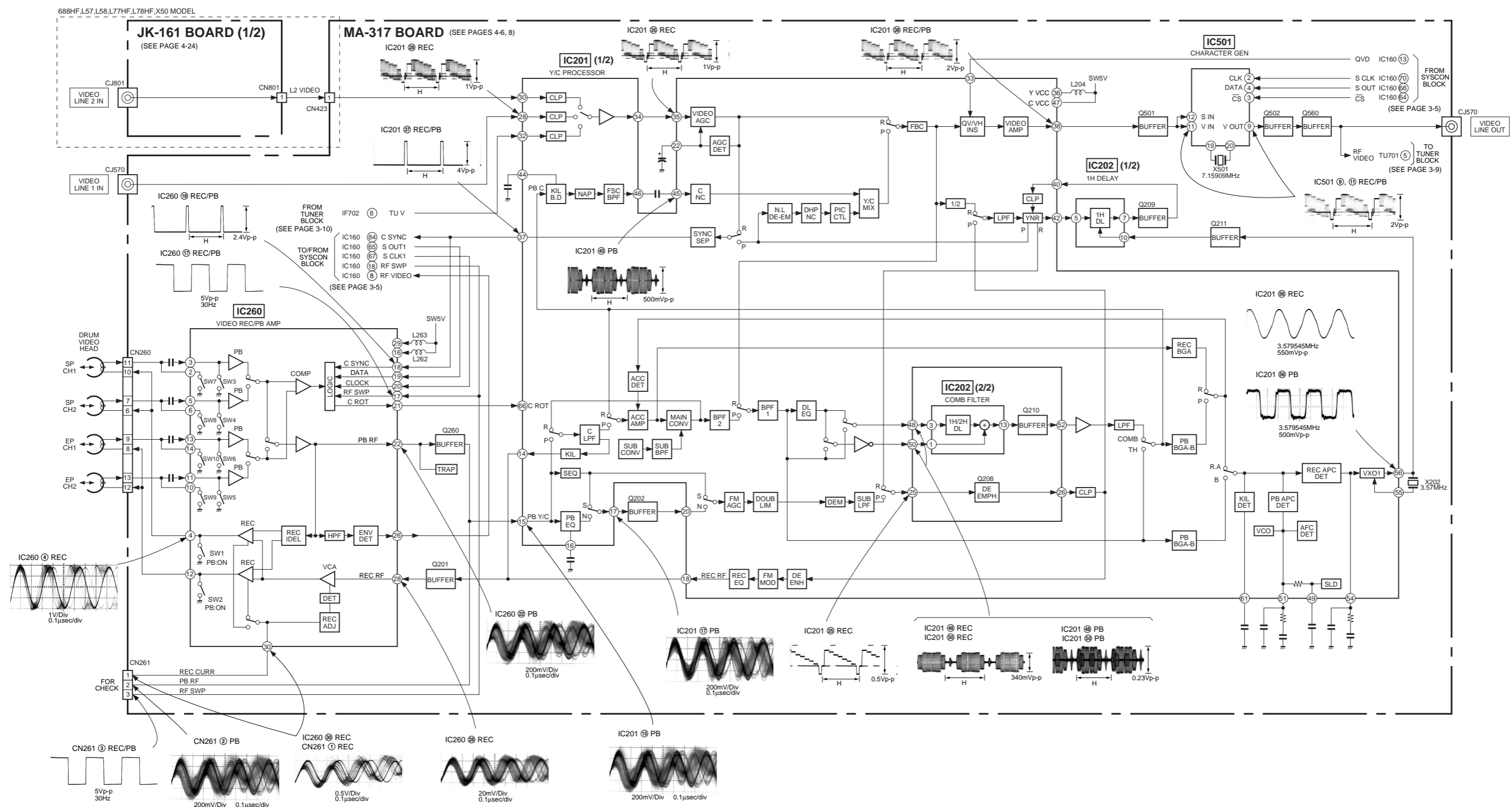

3-3. SERVO/SYSTEM CONTROL BLOCK DIAGRAM

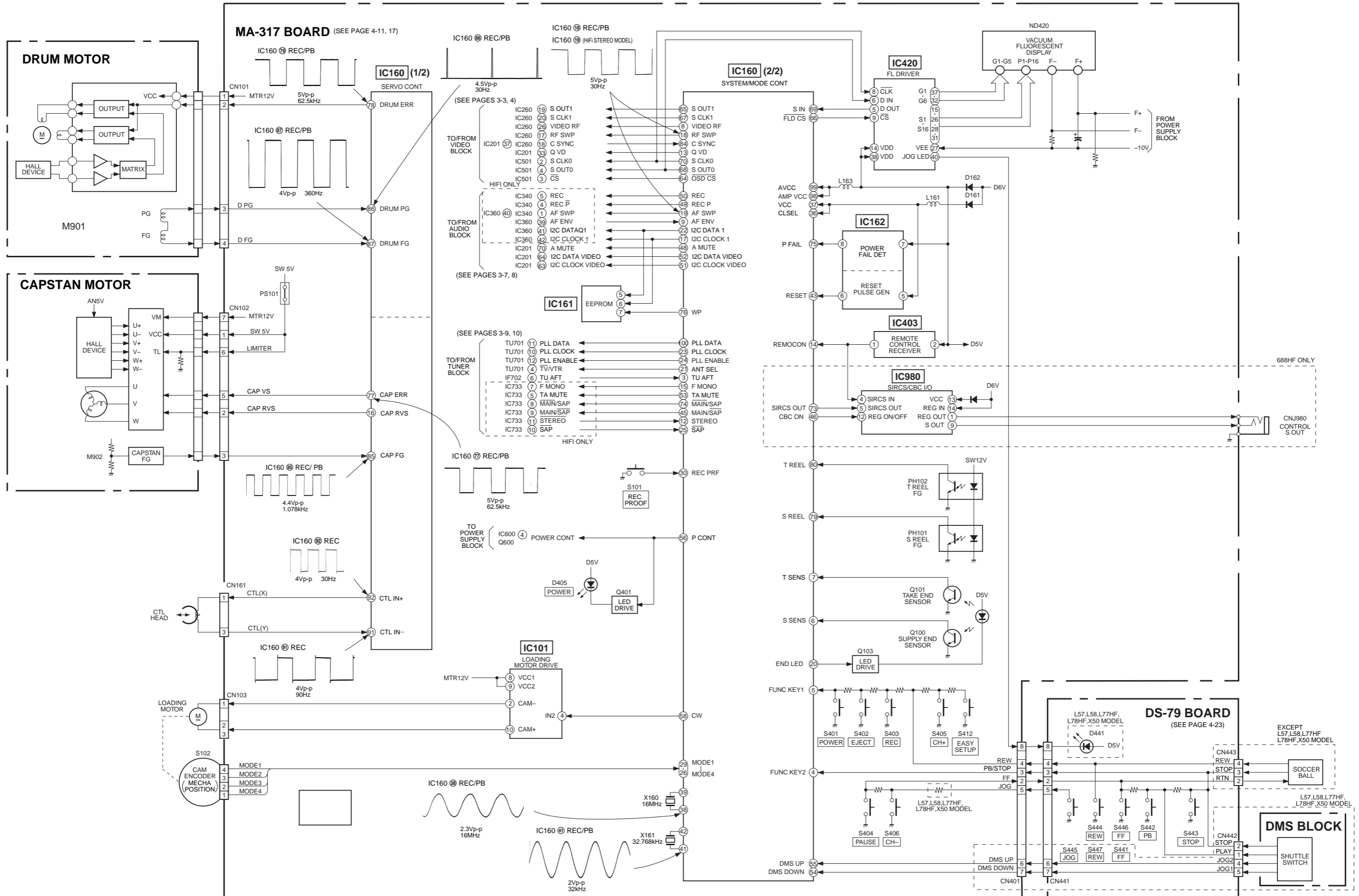

3-4. AUDIO BLOCK DIAGRAM

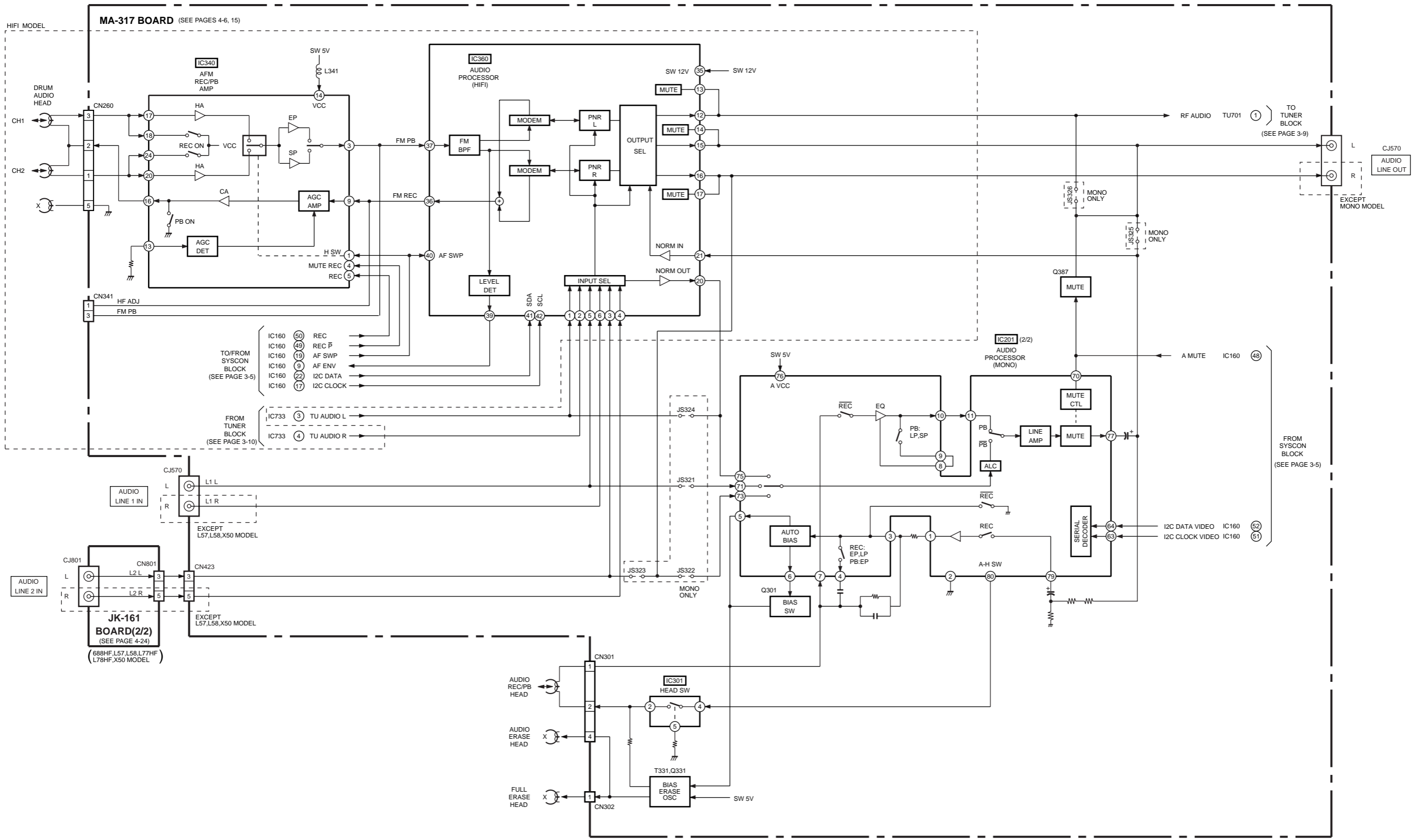

3-5. TUNER BLOCK DIAGRAM

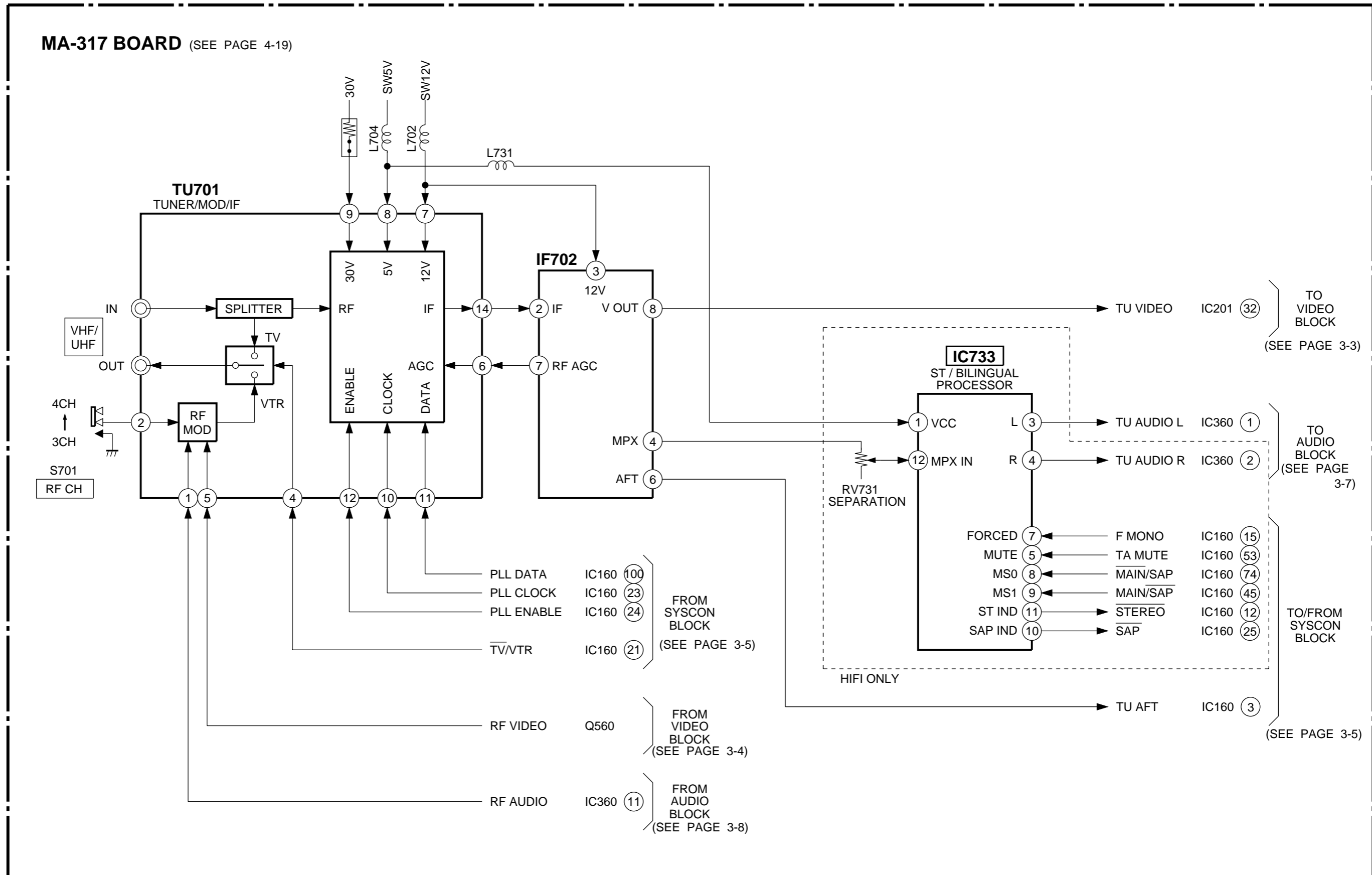

3-6. POWER SUPPLY BLOCK DIAGRAM

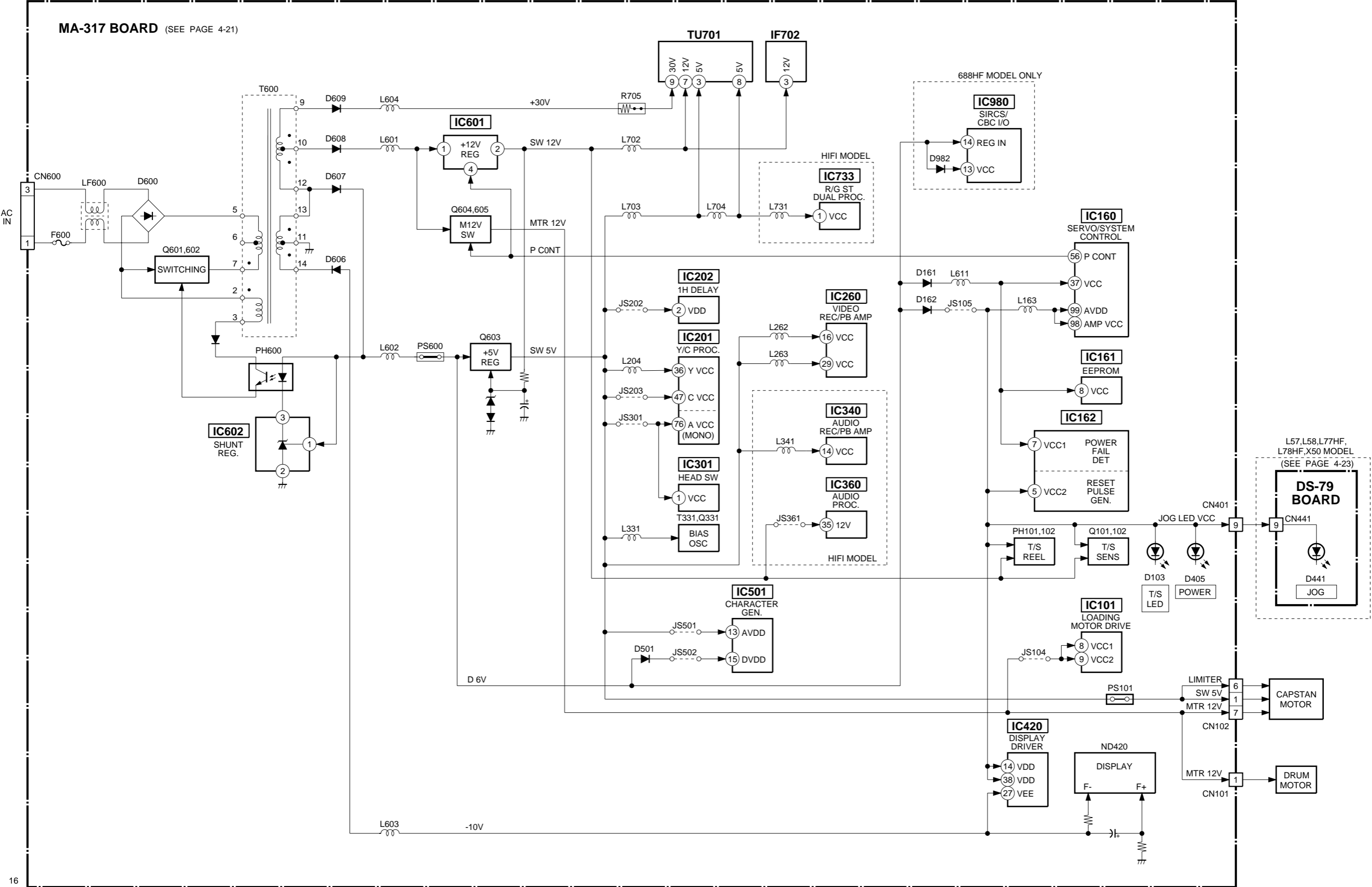

SECTION 4
PRINTED WIRING BOARDS AND SCHEMATIC DIAGRAMS

4-1. FRAME SCHEMATIC DIAGRAM

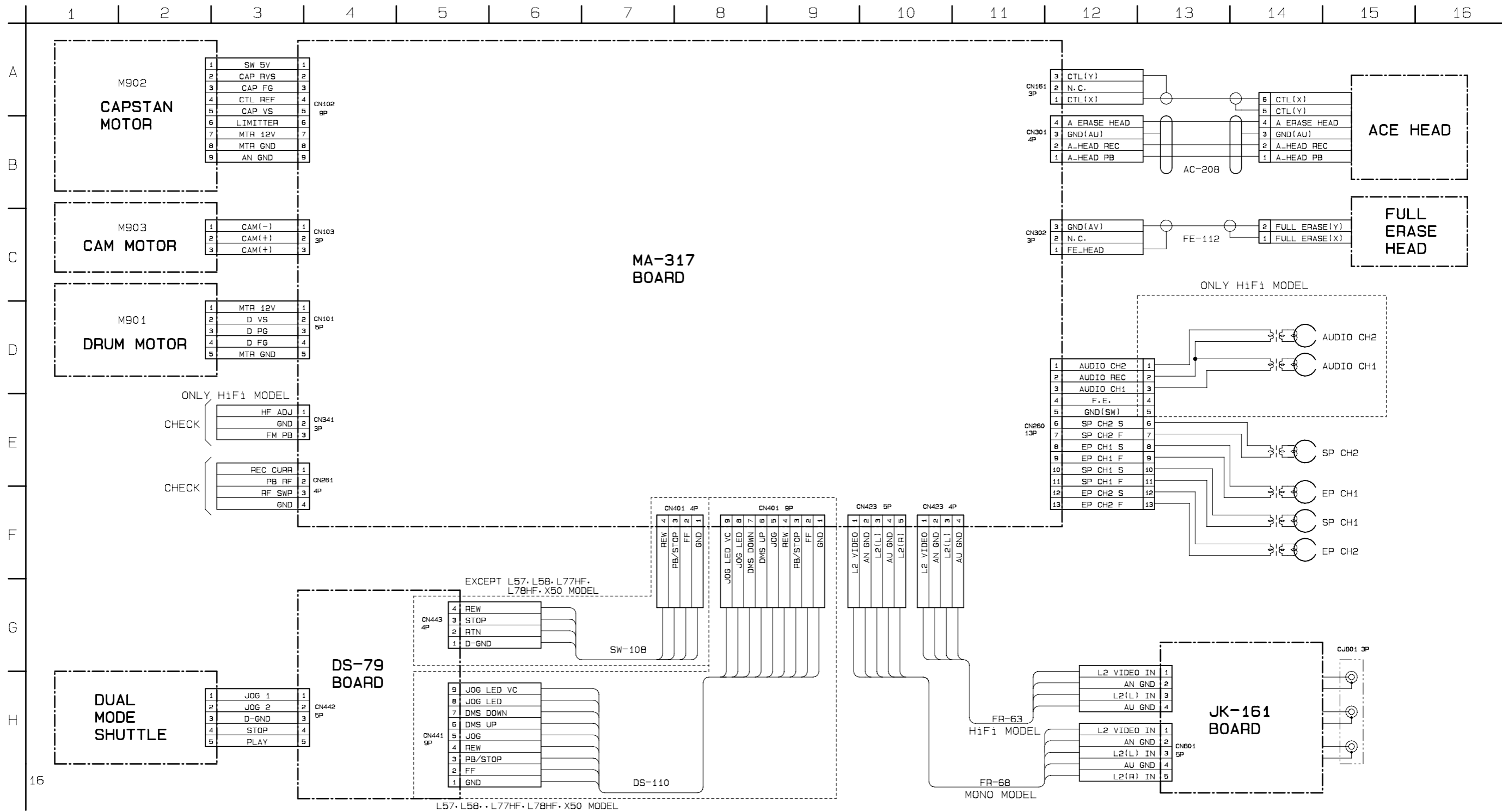

There are few cases that the part printed on this diagram isn't mounted in this model.

4-2. PRINTED WIRING BOARDS AND SCHEMATIC DIAGRAMS

MA-317 (REC/PB AMP, VIDEO, SERVO/SYSTEM CONTROL, AUDIO, MODE CONTROL, TUNER, POWER SUPPLY) PRINTED WIRING BOARD
— Ref. No.: MA-317 board; 1,000 series —

MA-317 (REC/PB AMP) SCHEMATIC DIAGRAM • See page 4-3 for MA-317 BOARD printed wiring board.
— Ref. No.: MA-317 board; 1,000 series —

MA-317 BOARD

CJ570	A-4	IC101	I-4
CN101	C-9	IC160	I-10
CN102	E-3	IC161	G-7
CN103	I-6	IC162	H-7
CN161	I-13	IC201	D-6
CN260	B-10	IC260	E-5
CN261	B-9	IC260	B-10
CN301	B-6	IC340	C-6
CN302	B-6	IC340	B-11
CN303	B-6	IC360	D-10
CN341	B-12	IC403	J-10
CN401	J-2	IC420	J-8
CN423	D-12	IC501	C-3
CN600	B-1	IC601	H-12
		IC602	F-1
CN1980	A-3	IC733	H-13
		IC980	B-4
D103	G-7		
D109	E-8	PH101	H-9
D161	H-3	PH102	H-6
D162	H-3	PH600	E-1
D382	A-12		
D383	A-12	Q101	F-3
D405	J-13	Q102	F-11
D501	B-4	Q103	G-8
D560	B-4	Q201	B-6
D600	C-1	Q202	C-6
D601	D-3	Q208	C-5
D602	E-2	Q209	D-5
D603	D-2	Q210	E-6
D604	D-2	Q211	E-6
D605	E-1	Q260	B-9
D606	G-1	Q301	C-7
D607	F-1	Q331	C-8
D608	F-2	Q387	A-12
D609	F-2	Q401	J-13
D610	G-2	Q501	C-4
D611	F-12	Q502	D-4
D612	F-12	Q560	B-5
D616	D-2	Q601	D-2
D702	C-13	Q602	C-1
D980	A-4	Q603	E-12
D981	A-4	Q604	I-1
D982	B-4	Q605	H-1

MA-317 BOARD (1/3)

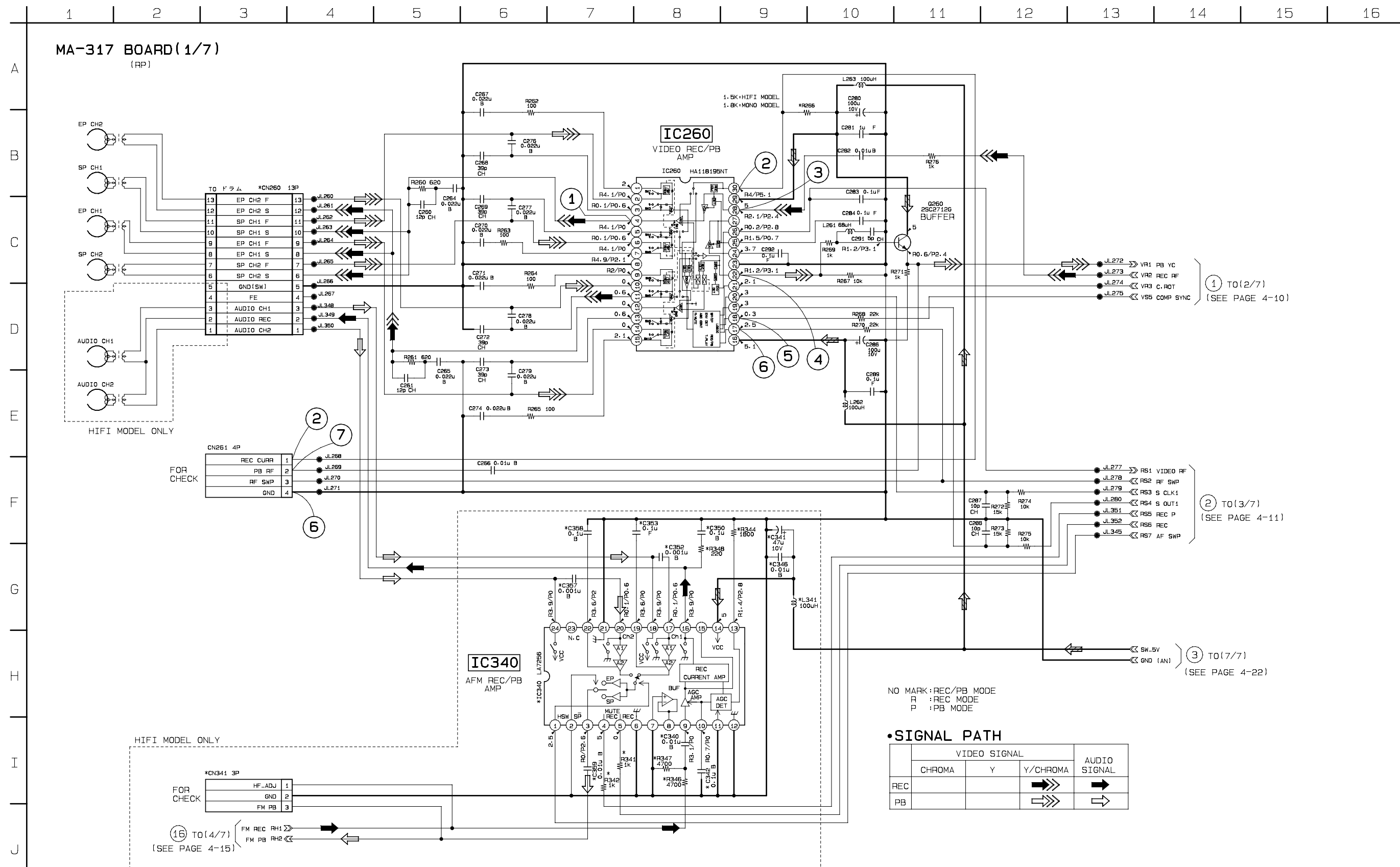
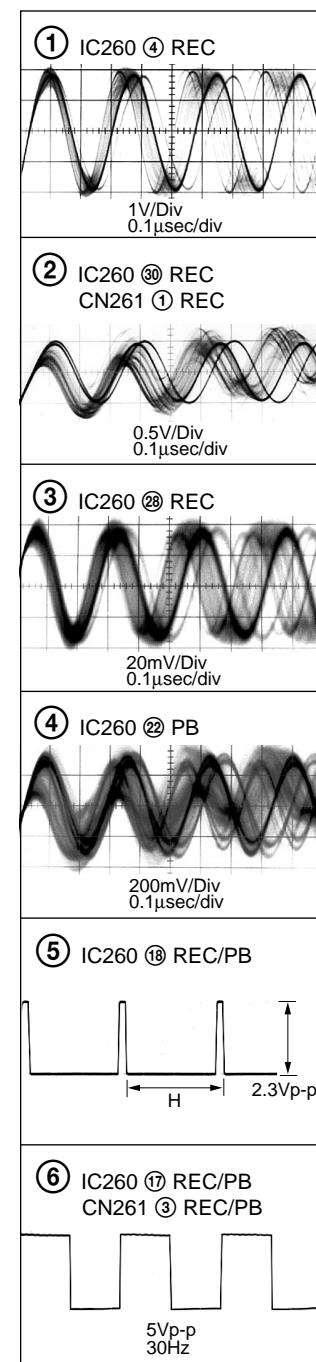

16

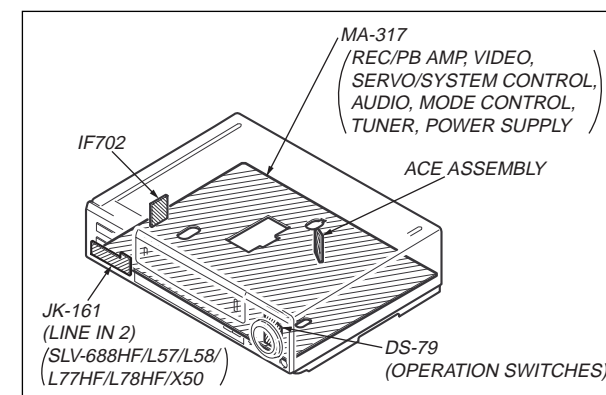

THIS NOTE IS COMMON FOR PRINTED WIRING BOARDS AND SCHEMATIC DIAGRAMS.
(In addition to this, the necessary note is printed in each block.)

- For printed wiring boards.
- — : Pattern from the side which enables seeing.

Caution :
Pattern face side: Parts on the pattern face side (Conductor Side) seen from the pattern face are indicated.
Parts face side: parts on the parts face side seen from the parts face are indicated.

- For schematic diagrams.
- Caution when replacing chip parts. New parts must be attached after removal of chip. Be careful not to heat the minus side of tantalum capacitor, because it is damaged by the heat.
- All resistor are in ohms, 1/4W unless otherwise noted. Chip resistor are 1/10W unless otherwise noted. kΩ: 1000Ω, MΩ: 1000kΩ.
- All capacitors are in µF unless otherwise noted. pF: µµF. 50V or less are not indicated except for electrolytics and tantalums.
- □ : panel designation.
- △ : internal component.
- — : B+ Line. *
- - - - : B- Line. *
- ▨ : IN/OUT direction of (+,-) B LINE. *
- Circled numbers refer to waveforms. *
- Readings are taken with a color-bar signal input.
- Voltage are dc between ground and measurement points.*
- Readings are taken with a digital multimeter (DC10MΩ).*
- Voltage variations may be noted due to normal production tolerances.*

When indicating parts by reference number, please include the board name.

- *: indicated by the color red.

NO MARK: REC/PB MODE
R : REC MODE
P : PB MODE

• SIGNAL PATH

	VIDEO SIGNAL			AUDIO SIGNAL
	CHROMA	Y	Y/CHROMA	
REC			→	→
PB			⇨	⇨

MA-317 BOARD (2/3)

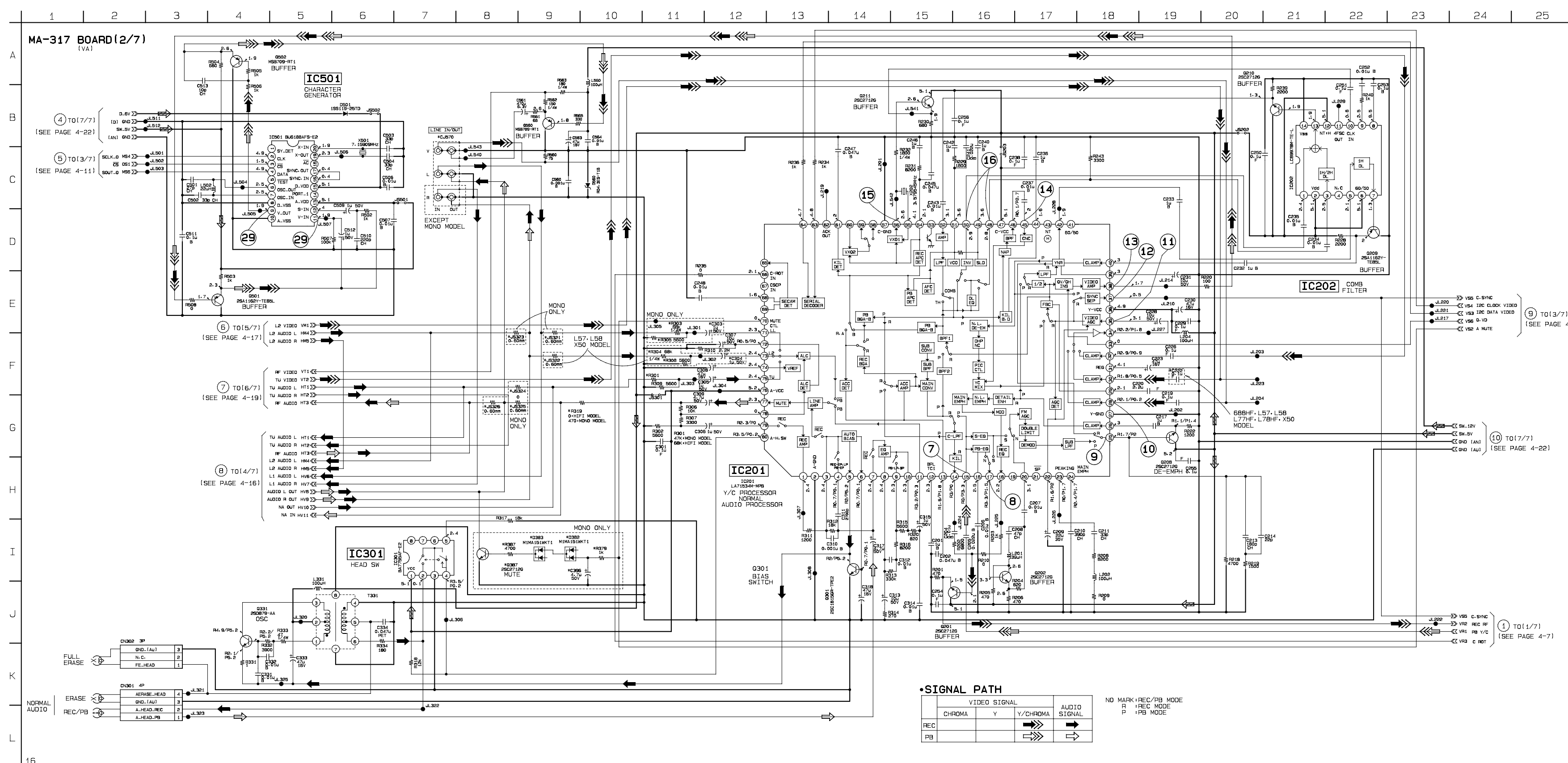
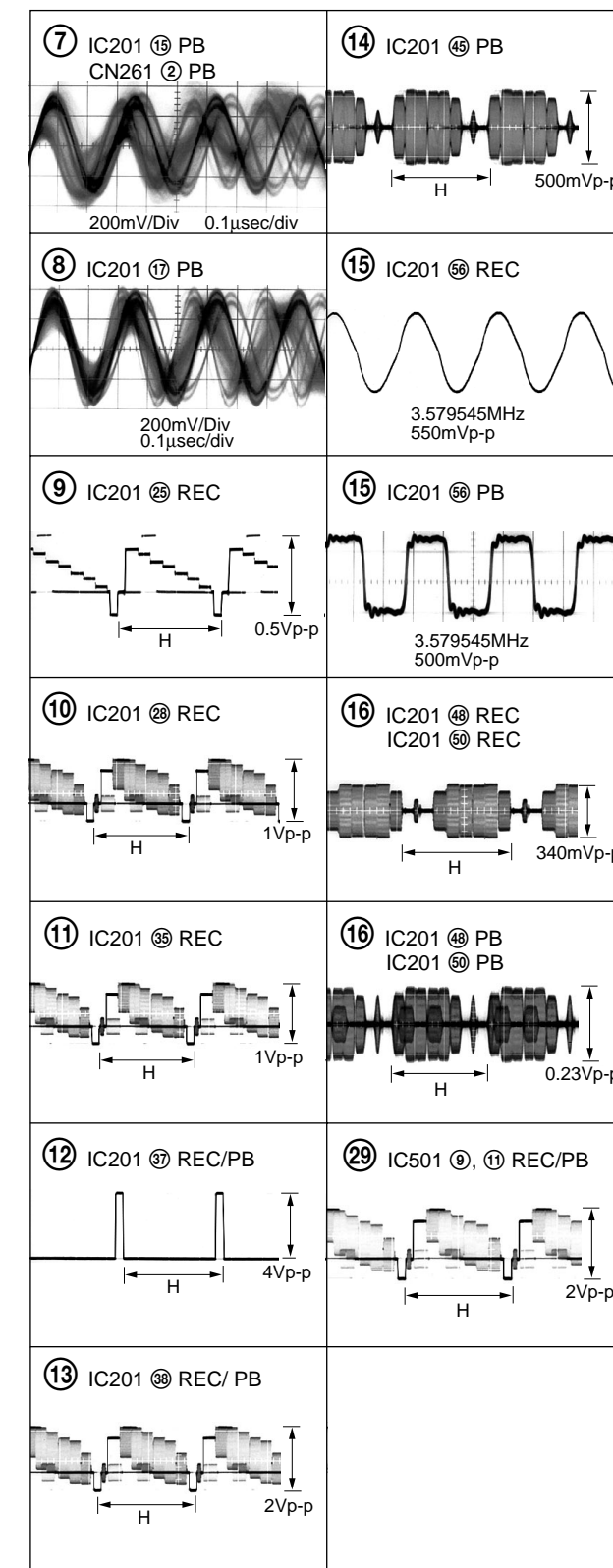

16

• SIGNAL PATH

	VIDEO SIGNAL			AUDIO SIGNAL
	CHROMA	Y	Y/CHROMA	
REC	→	→	→	→
PB	→	→	→	→

NO MARK: REC/PB MODE
R: REC MODE
P: PB MODE

MA-317 (SERVO/SYSTEM CONTROL) SCHEMATIC DIAGRAM

— Ref. No.: MA-317 board; 1,000 series —

• See page 4-3 for MA-317 BOARD printed wiring board.

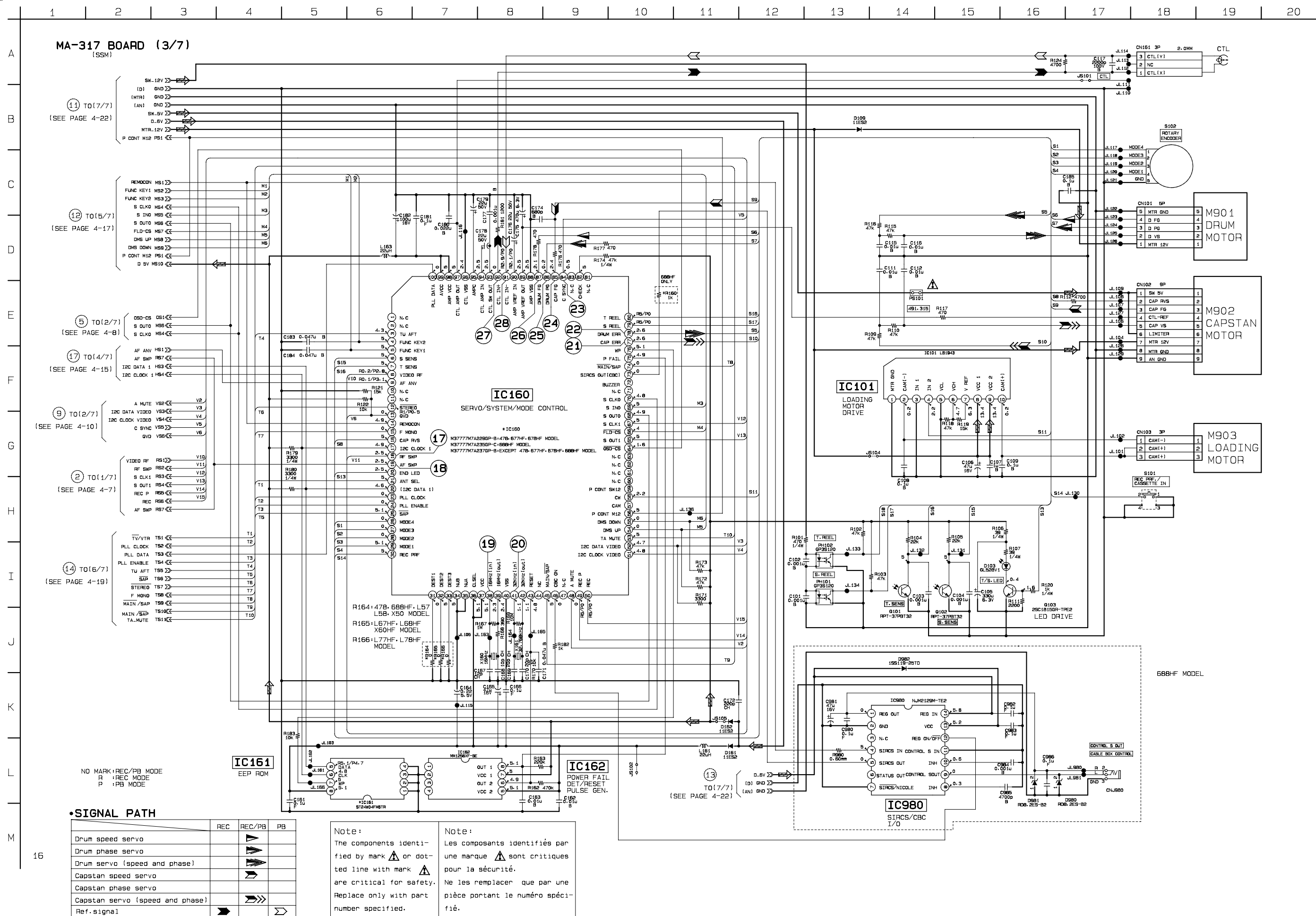

MA-317 BOARD (3/3)

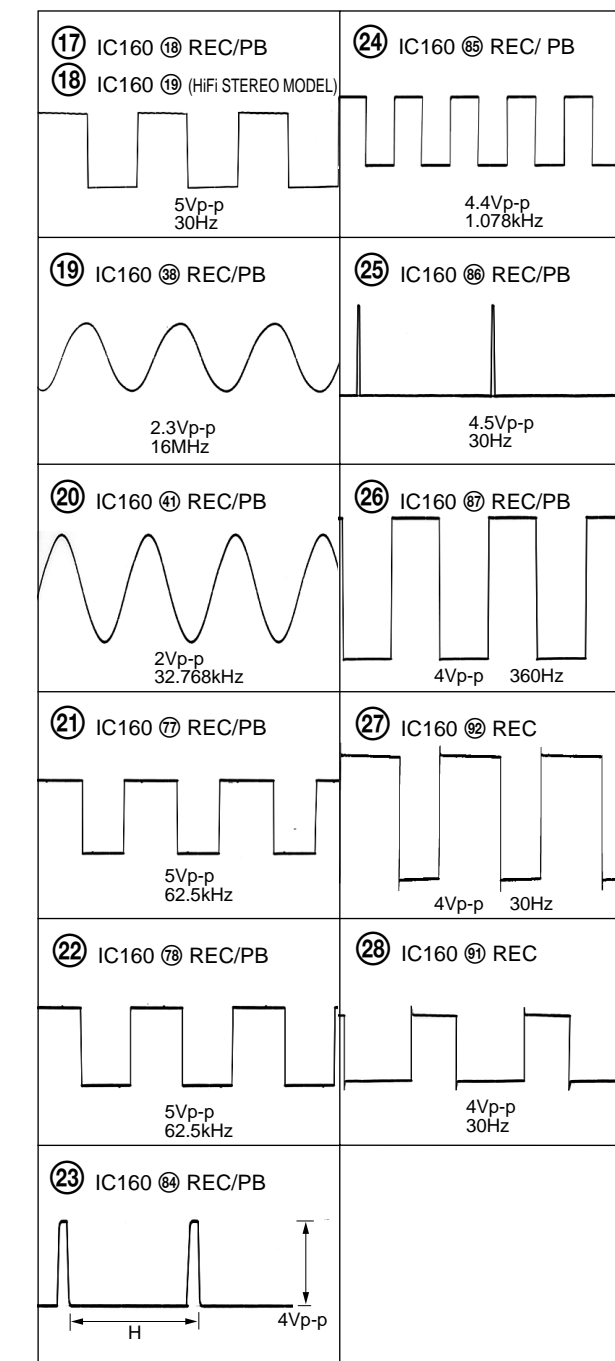

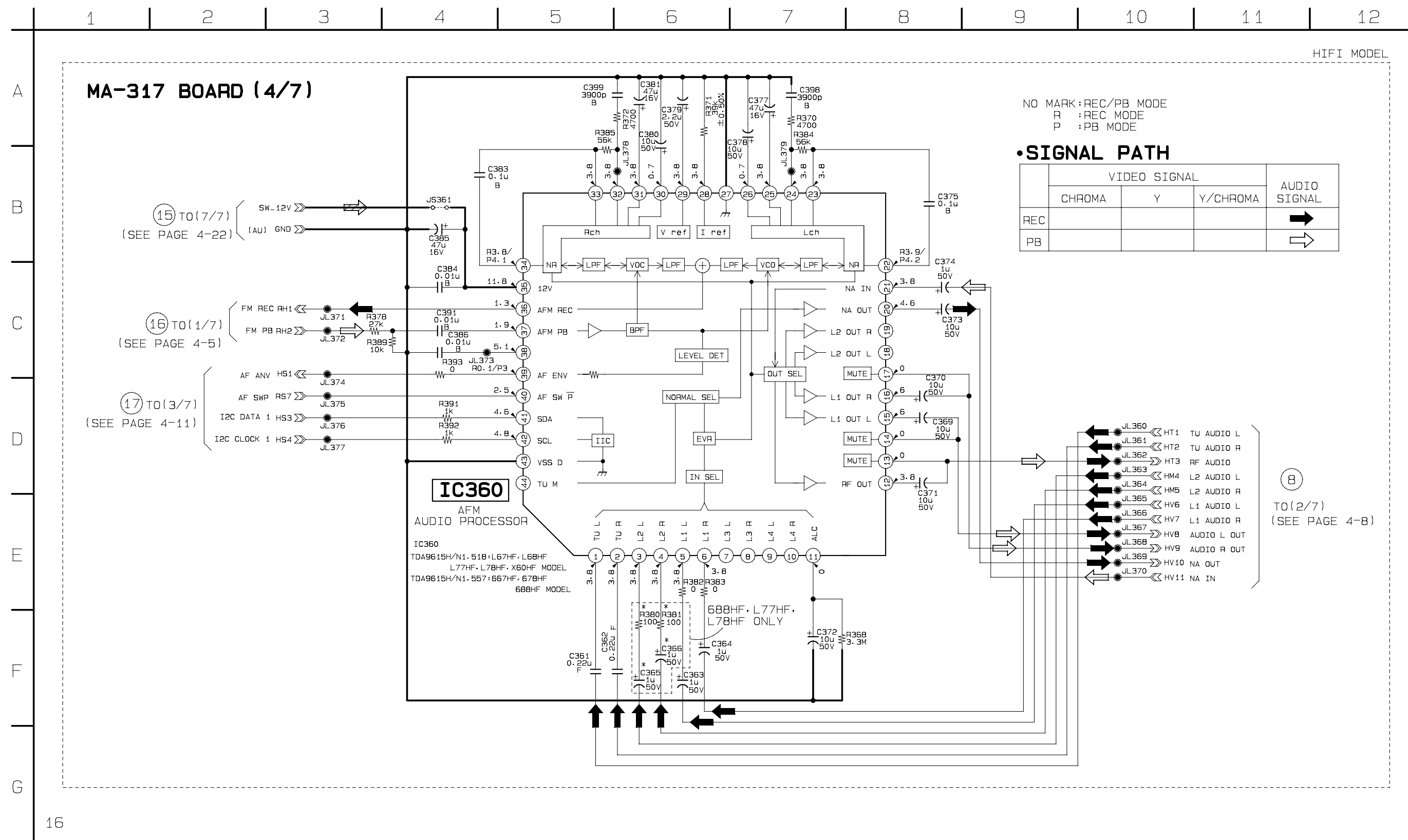

MA-317 (MODE CONTROL) SCHEMATIC DIAGRAM

• See page 4-3 for MA-317 BOARD printed wiring board.

— Ref. No.: MA-317 board; 1,000 series —

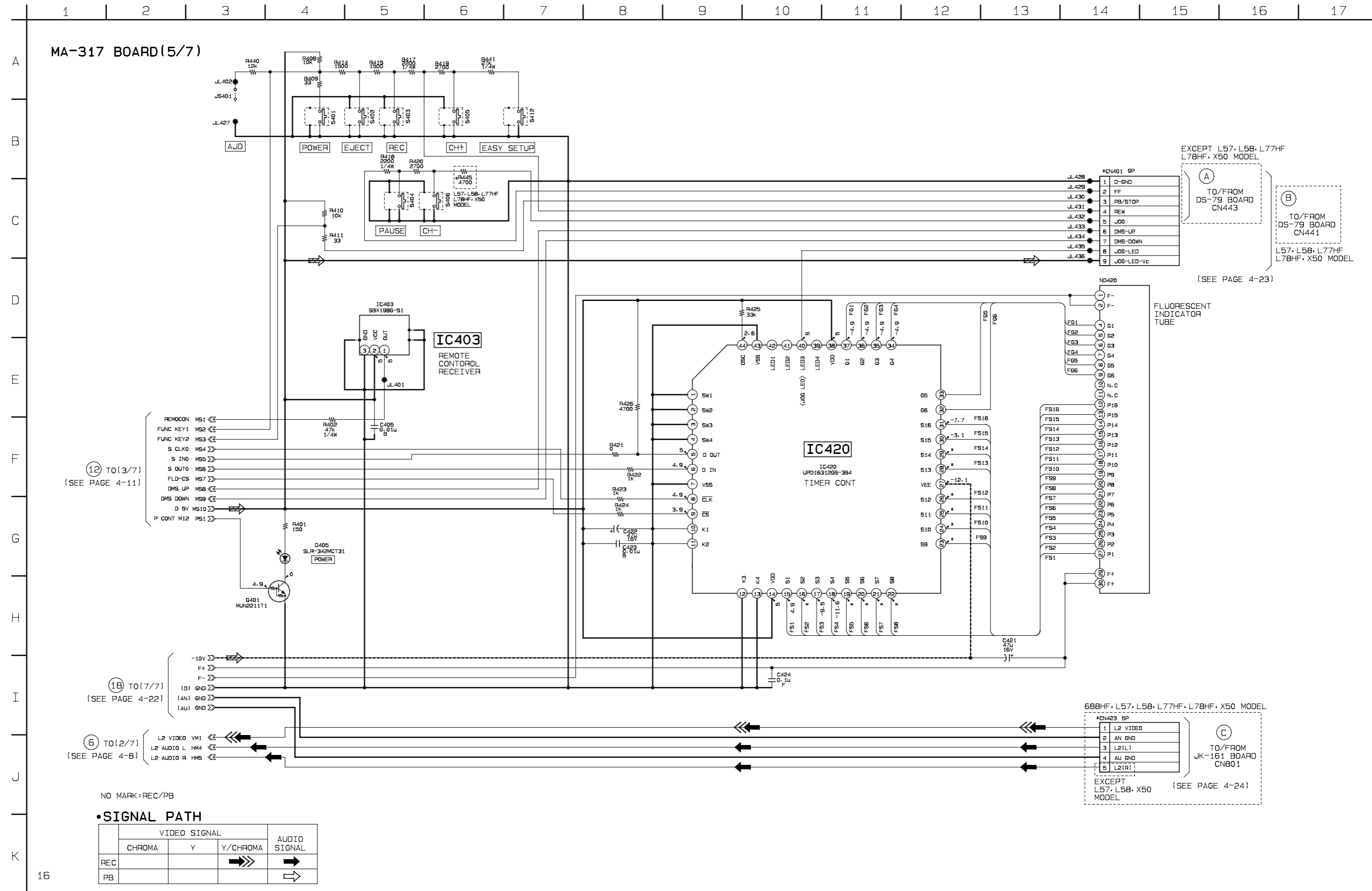

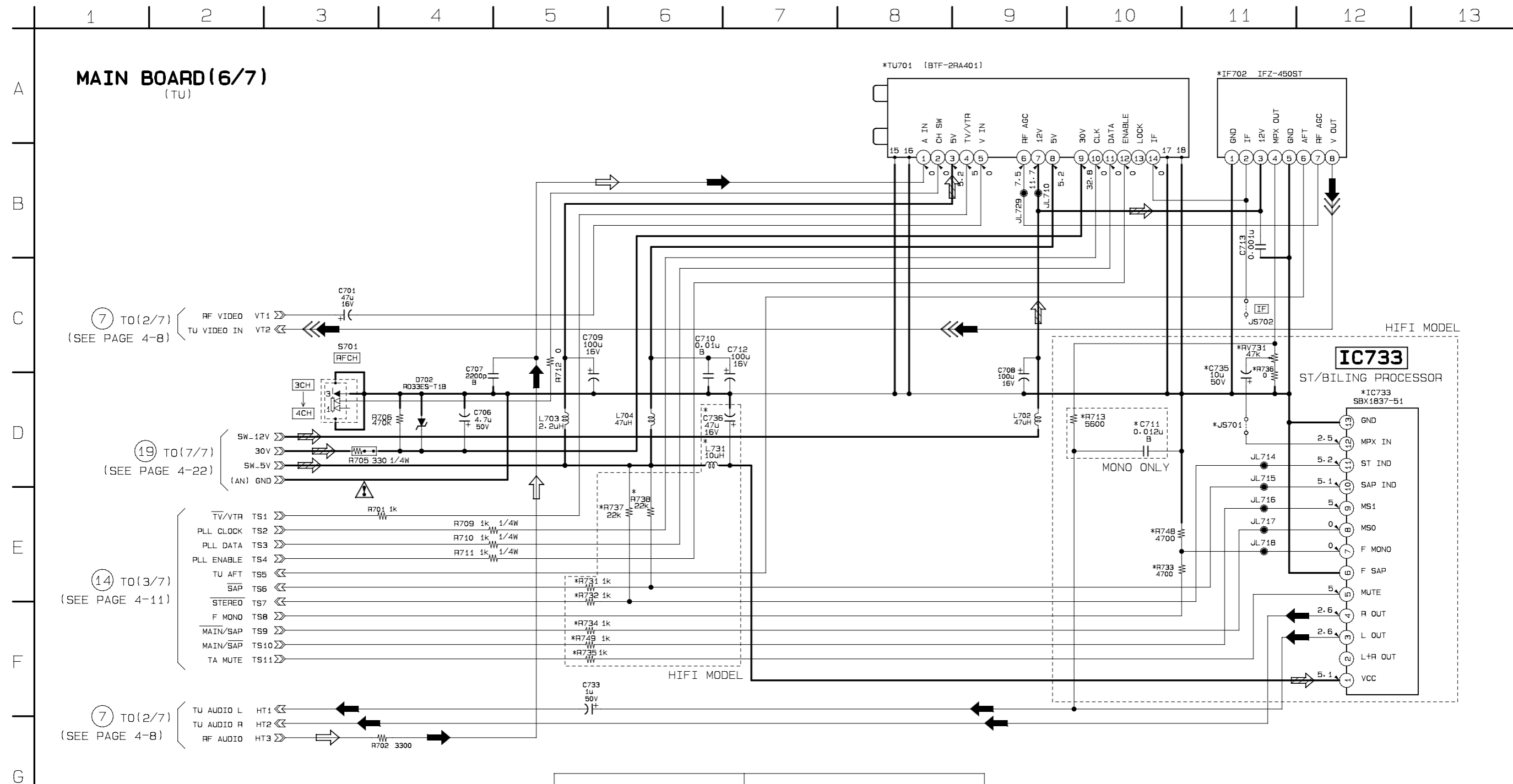

NO MARK: E-E MODE

• SIGNAL PATH

	VIDEO SIGNAL			AUDIO SIGNAL
	CHROMA	Y	Y/CHROMA	
REC			➡➡➡	➡
PB				➡

Note:
The components identified by mark or dotted line with mark are critical for safety. Replace only with part number specified.

Note:
Les composants identifiés par une marque sont critiques pour la sécurité. Ne les remplacer que par une pièce portant le numéro spécifié.

MA-317 (POWER SUPPLY) SCHEMATIC DIAGRAM
— Ref. No.: MA-317 board; 1,000 series —

• See page 4-3 for MA-317 BOARD printed wiring board.

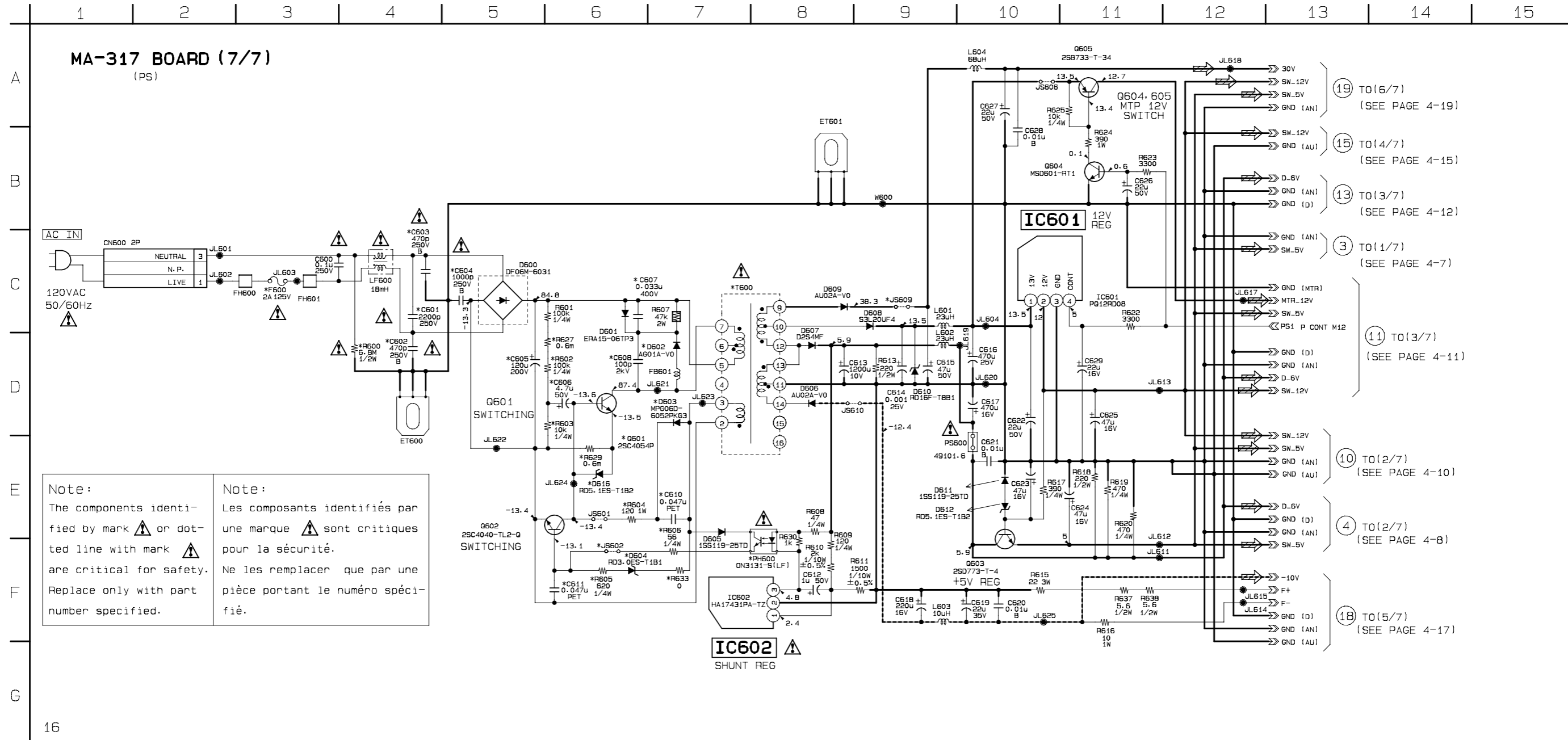

DS-79 (OPERATION SWITCHES) PRINTED WIRING BOARD AND SCHEMATIC DIAGRAM

— Ref. No.: DS-79 board; 1,000 series —

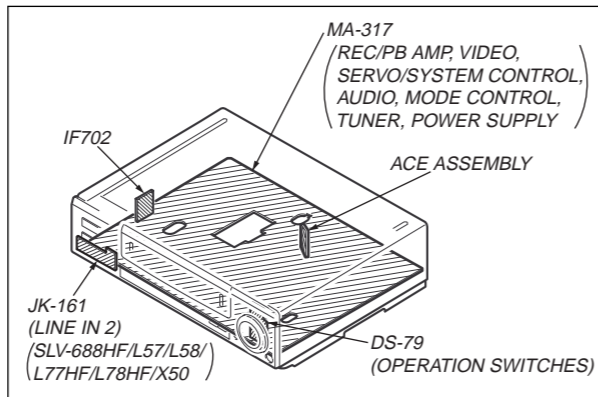
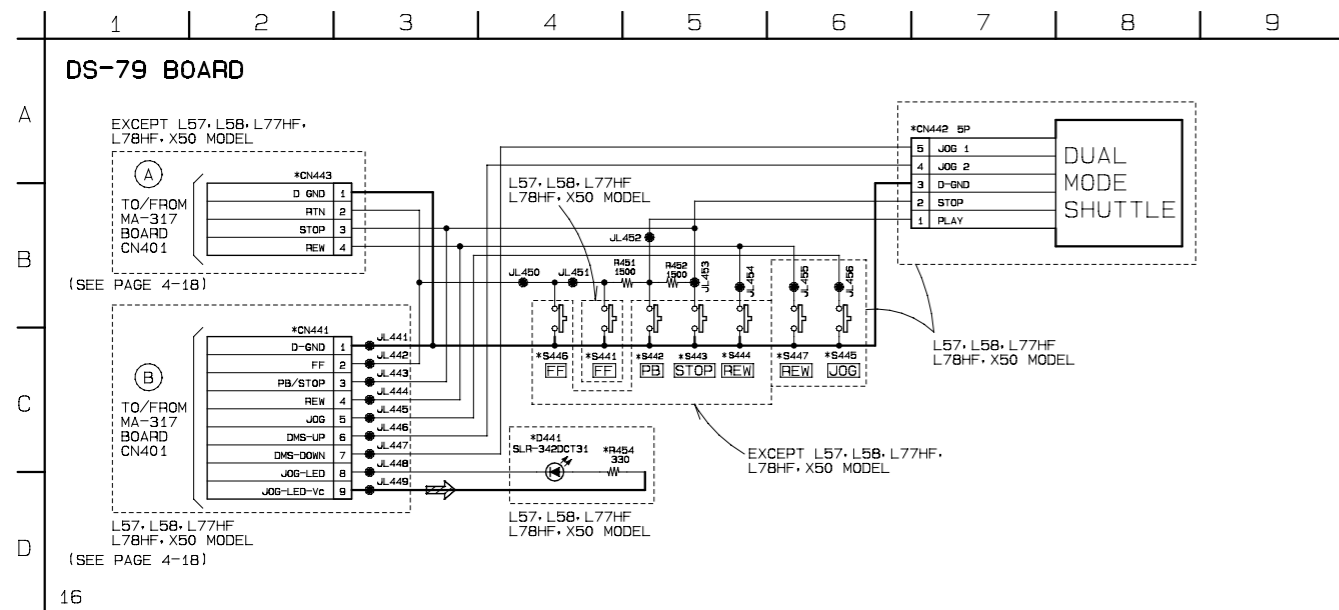

JK-161 (LINE IN 2) PRINTED WIRING BOARD AND SCHEMATIC DIAGRAM

— Ref. No.: JK-161 board; 2,000 series —

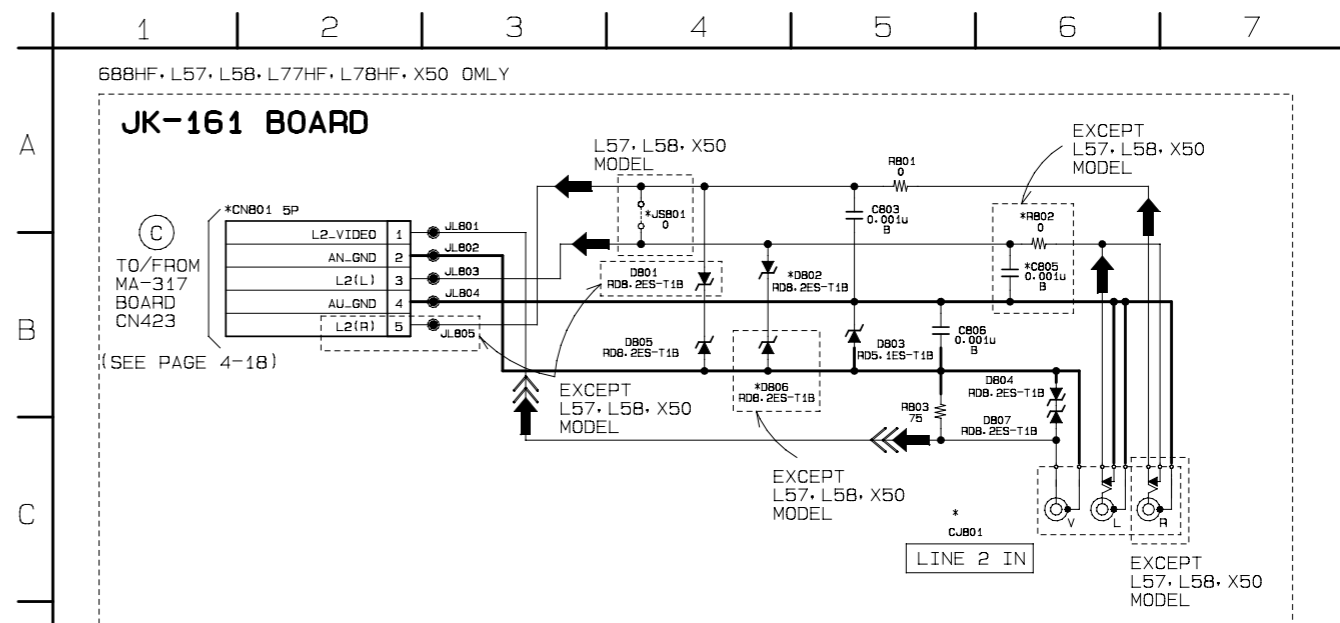

• SIGNAL PATH

	VIDEO SIGNAL			AUDIO SIGNAL
	CHROMA	Y	Y/CHROMA	
REC			→→→	→
PB				→

SECTION 5
INTERFACE, IC PIN FUNCTION DESCRIPTION

5-1. SYSTEM CONTROL — MECHANISM BLOCK INTERFACE (MA-317 board IC160)

Signal	Pin No.	I/O	EJECTED	CASSETTE LOADING	CASSETTE UNLOADING	TAPE THREADING	TAPE UNTHREADING	STOP	FF	REW	PB	REC
CW	MA-317 Board IC160 ⑥⑧	O	*5	H	L	H	L	*5	*5	*5	*5	*5
MODE 1	MA-317 Board IC160 ②⑨	I	—	—	—	—	—	H	H	H	H	H
MODE 2	MA-317 Board IC160 ③⑩	I	—	—	—	—	—	L	L	L	H	H
MODE 3	MA-317 Board IC160 ④⑪	I	—	—	—	—	—	H	H	H	L	L
MODE 4	MA-317 Board IC160 ⑤⑫	I	—	—	—	—	—	H	L	L	L	L
REC PRF	MA-317 Board IC160 ⑩⑬	I	L	*1	*1	*1	*1	*1	*1	*1	*1	*1
T REEL	MA-317 Board IC160 ⑩⑭	I	H/L	H/L	H/L	H/L	H/L	H/L	*2	*2	*2	*2
S REEL	MA-317 Board IC160 ⑩⑮	I	H/L	H/L	H/L	*2	*2	H/L	*2	*2	*2	*2
END LED	MA-317 Board IC160 ⑩⑯	O	L	*3	*3	*3	*3	*3	*3	*3	*3	*3
T SENS	MA-317 Board IC160 ⑩⑰	I	*3	*3	*3	*4	*4	*4	*4	*4	*4	*4
S SENS	MA-317 Board IC160 ⑩⑱	I	*3	*3	*3	*4	*4	*4	*4	*4	*4	*4

- *1. "L" When erasing protection tab is bent. "H" when not bent.
- *2. Pulse of period in proportion to reel rotating speed.
- *3. Approx. 2 msec period "H" pulse when tape top or end is detected.
- *4. Normally "L". 2 msec period "H" pulse when tape top or end is detected.
- *5. Hi-Z

**5-2. SYSTEM CONTROL — SERVO PERIPHERAL CIRCUIT INTERFACE
(MA-317 board IC160)**

Signal	Pin No.	I/O	STOP	FF	REW	TAPE THREADING	TAPE UNTHREADING	PB	REC
CTL IN+	MA-317 Board IC160 ②⑲	O	*7	*7	*7	*7	*7	*7	*1
DRUM PG	MA-317 Board IC160 ③⑳	I	*3	*3	*3	*3	*3	*3	*3
DRUM FG	MA-317 Board IC160 ④㉑	I	*4	*4	*4	*4	*4	*4	*4
CAP FG	MA-317 Board IC160 ⑤㉒	I	H/L	*2	*2	*5	*5	*2	*2
CAP RVS	MA-317 Board IC160 ⑥㉓	O	H/L	L	H	L	H	L	L
CAP ERR	MA-317 Board IC160 ⑦㉔	O	L	*6	*6	*6	*6	*6	*6
DRUM ERR	MA-317 Board IC160 ⑧㉕	O	*6	*6	*6	*6	*6	*6	*6

- *1. 30 Hz pulse
- *2. Pulse of period in proportion to tape speed.
- *3. 30 Hz "H" pulse.
- *4. 720 Hz pulse.
- *5. Unstable period pulse.
- *6. DC voltage 1 ~ 5V.
- *7. Hi-Z (2.5V).

5-3. SYSTEM CONTROL — SYSTEM CONTROL PERIPHERAL CIRCUIT INTERFACE (MA-317 board IC160)

Signal	Pin No.	I/O	I/O level
RESET	MA-317 Board IC160 ④	I	Normally "H". "L" when service interruption detected or restored.
I2C DATA1	MA-317 Board IC160 ②	I/O	Serial communication data to audio microprocessor and EEPROM I2C161.
I2C CLOCK1	MA-317 Board IC160 ⑦	O	Serial communication clock to audio microprocessor and EEPROM I2C161.
I2C DATA VIDEO	MA-317 Board IC160 ⑤	I/O	Serial communication data to video microprocessor.
I2C CLOCK VIDEO	MA-317 Board IC160 ⑥	O	Serial communication clock to video microprocessor.
(RP) S OUT1	MA-317 Board IC160 ⑧	I/O	Serial communication data to RP microprocessor.
(RP) S CLK1	MA-317 Board IC160 ⑦	O	Serial communication clock to RP microprocessor.

5-4. SYSTEM CONTROL AND RF MODULATOR — INPUT SELECTION BLOCK INTERFACE (MA-317 board IC160)

Signal	Pin No.	I/O	I/O level
ANT SEL	MA-317 Board IC160 ②	O	"L" when RF modulator through.

5-5. SYSTEM CONTROL — VIDEO/RP BLOCK INTERFACE (MA-317 board IC160)

Signal	Pin No.	I/O	STOP/FF /REW	TAPE LOADING	TAPE UNLOADING	PB	REC	REC PAUSE
RF SWP	MA-317 Board IC160 ⑩	O	*1	*1	*1	*1	*1	*1
QVD	MA-317 Board IC160 ⑬	O	L	L	L	*2	L	L
REC P	MA-317 Board IC160 ⑨	O	L	L	L	L	L	H
C SYNC	MA-317 Board IC160 ⑭	I	*3	*3	*3	*3	*3	*3

*1. Synchronized with drum rotation. 30Hz 50% duty pulse.

*2. Normal "L". "H" when video signal is not regenerated.

*3. Composite sync signal (positive).

5-6. SYSTEM CONTROL — AUDIO BLOCK INTERFACE (MA-317 board IC160)

Signal	Pin No.	I/O	STOP/FF /REW	TAPE LOADING	TAPE UNLOADING	PB	REC	REC PAUSE
A MUTE	MA-317 Board IC160 ④	O	L	L	L	L	L	H

5-7. SERVO/SYSTEM CONTROL MICROPROCESSOR (MA-317 BOARD IC160)

Pin.No.	Signal	I/O	Function	Pin.No.	Signal	I/O	Function
1	—	—	—	51	I2C CLOCK VIDEO	O	I2C clock (Video)
2	—	—	—	52	I2C DATA VIDEO	O	I2C data (Video)
3	TU AFT	I	Tuner analog AFT input	53	TAMUTE	O	Tuner-audio mute
4	FUNC KEY 2	I	key input	54	DMS UP	I	DMS control
5	FUNC KEY 1	I	key input	55	DMS DOWN	I	DMS control
6	SSENS	I	Tape end sensor	56	P CONT M12	O	Motor 12V control
7	TSENS	I	Tape top sensor	57	—	—	—
8	VIDEO RF	I	Video RF input	58	CW	I/O	Cam motor control 2
9	AF ENV	I	HIFI envelope	59	P CONT SW12	O	SW 12V control
10	—	—	—	60	—	—	—
11	—	—	—	61	—	—	—
12	STEREO	I	Tuner stereo detection input L: Stereo	62	—	—	—
13	QVD	O	Quasi VD	63	—	—	—
14	REMOCON	I	Infrared ray catcher	64	OSD CS	O	OSD chip select
15	F MONO	O	Forced mono	65	SOUT 1	O	Serial out Ch1 (RP)
16	CAP RVS	O	Captian reverse	66	FLD CS	O	Fluorescent display driver chip select
17	I2C CLOCK 1	O	I2C clock (EEPROM, HIFI, PLL, MOD)	67	SCLK 1	O	Serial clock Ch1 (RP)
18	RF SWP	O	RF switching pulse	68	SOUT 0	O	Serial out Ch0 (FLD, OSD)
19	AF SWP	O	HIFI switching pulse	69	SIN 0	I	Serial in Ch0 (FLD, OSD)
20	END LED	O	End sensor LED output	70	SCLK 0	O	Serial clock Ch0 (FLD, OSD)
21	ANT SEL	O	TV/VTR RF modulator	71	—	—	—
22	I2C DATA 1	I/O	I2C data (EEPROM, HIFI, PLL, MOD)	72	BUZZER	I/O	Buzzer
23	PLL CLK	O	Tuner PLL clock	73	SIRCS OUT (CBC)	O	Remote control signal output (CBC)
24	PLL ENABLE	O	Tuner enable	74	MAIN/SAP	O	MAIN/SAP select
25	SAP	I	SAP discrimination	75	PFAIL	I	Power fail detection input
26	MODE 4	I	Cam encoding data 4	76	WP	O	EEPROM write protect
27	MODE 3	I	Cam encoding data 3	77	CAPERR	O	Captian error output
28	MODE 2	I	Cam encoding data 2	78	DRUM ERR	O	Drum error output
29	MODE 1	I	Cam encoding data 1	79	SREEL	I	Supply reel sensor
30	RECPRF	I	Mis-record prevention switch signal input	80	TREEL	I	Take-up reel sensor
31	DEST1	I	Destination discrimination input 1	81	—	—	—
32	DEST2	I	Destination discrimination input 2	82	CHECK	I	Check input
33	DEST3	I	Destination discrimination input 3	83	—	—	—
34	NUB	I	Ground	84	CSYNC	I	Composite sync signal input
35	NUA	I	Ground	85	CAPFG	I	Captian FG signal input
36	CLSEL	I	5V	86	DRMPG	I	Drum FG signal input
37	VCC	I	5V	87	DRMFG	I	Drum FG signal input
38	16 MHz (in)	I	16MHz	88	AMP VSS	I	CTL amp
39	16 MHz (out)	O	16MHz	89	AMP VREF OUT	O	CTL amp
40	VSS	I	Ground	90	AMP VREF IN	I	CTL amp
41	32 kHz (in)	I	32kHz	91	CTLIN-	I/O	CTL signal I/O
42	32 kHz (out)	O	32kHz	92	CTLIN+	I/O	CTL signal I/O
43	RESET	I	Reset signal input	93	CTL SWOUT	O	CTL amp
44	—	—	—	94	CTL AMP IN	I	CTL amp
45	MAIN/SAP	O	MAIN/SAP judge signal out	95	AMPC	I	CTL amp
46	CBC ON	O	Cable box control signal output	96	CTL VSS	I	CTL amp
47	—	—	—	97	CTL AMP OUT	O	CTL amp
48	AMUTE	O	Audio mute	98	AMPVCC	I	CTL amp
49	RECP	O	HIFI audio record control	99	AVCC	I	AN5V
50	REC	O	Audio record control L: Playback	100	PLL DATA	O	Tuner PLL data

SECTION 6 ADJUSTMENTS

6-1 MECHANICAL ADJUSTMENTS

For the mechanical adjustments, please refer to the "VHS MECHANICAL ADJUSTMENT MANUAL VI (S MECHANISM)" (9-921-647-11).

6-2. ELECTRICAL ADJUSTMENTS

HiFi model: SLV-677HF/678HF/688HF/L67HF/L68HF/
L77HF/L78HF/X60HF
Mono model: SLV-478/L47/L48/L57/L58/X50

See the adjusting part location diagram from on page 6-8 for the adjustment.

2-1. PREPARATION BEFORE ADJUSTMENT

2-1-1. Equipment Required

The measuring instruments used for this alignment include:

- 1) Monitor TV
- 2) Oscilloscope, dual-trace, bandwidth of 30MHz or more, with delay mode (A probe 10:1 should be used unless otherwise specified.)
- 3) Frequency counter
- 4) Pattern generator
- 5) Digital voltmeter
- 6) Audio generator
- 7) Audio level meter
- 8) Audio distortion meter
- 9) Audio attenuator
- 10) Alignment tapes
KRV-51N2 Part No.: 8-192-605-32

2-1-2. Equipment Connection

Unless otherwise specified, connect and adjust the measuring instruments as shown in the following diagram.

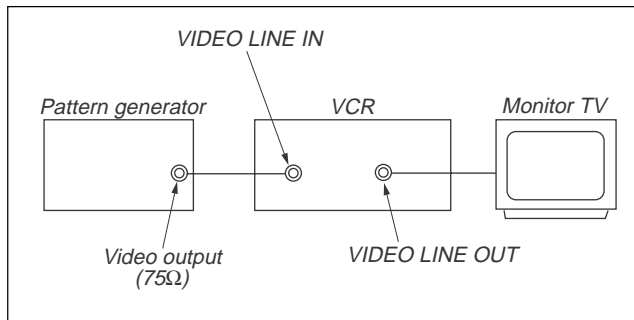

Fig. 6-2-1.

2-1-3. Input Signal Check

Video signal produced by a pattern generator is used as an adjustment signal to perform electrical alignment for this unit. This video signal must satisfy the specification.

Unless otherwise specified, place the switches and controls of this unit in the following positions:

- **INPUT SELECT** switch LINE or LINE 1
(Remote commander)

Connect an oscilloscope to the Video Input terminal. Check that the synchronizing signal of the Y signal has an amplitude of approximately 0.7V and that the burst signal has an amplitude of approximately 0.3V and its waveform is flat. And check that the level ratio of burst signal to "red" signal is 0.30 : 0.66. The video signal (color bar) used for electrical aligning this unit is shown in Fig. 6-2-2.

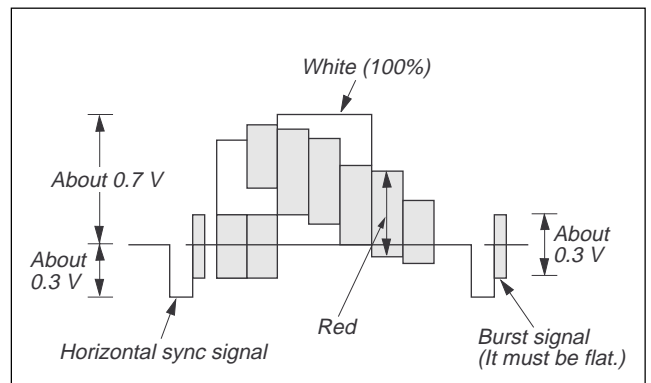

Fig. 6-2-2. Color Bar Signals of Pattern Generator

2-1-4. Alignment Tape

- Contents of KRV-51N2

	Mode	Period	Video signal	Audio signal	
				Hi-Fi	Normal
1	SP	7 minutes	Color bar	400Hz	400Hz
2		3 minutes	Monoscope		
3	EP	7 minutes	Color bar		
4		3 minutes	Monoscope		

2-1-5. Input/Output Levels and Impedance

Video input: LINE IN
 Input signal: 1Vp-p, 75ohms, unbalanced, sync negative

Video output: LINE OUT
 Output signal: 1Vp-p, 75ohms, unbalanced, sync negative

Audio input: LINE IN
 Input level: -7.5 dBs
 (0dBs= 0.775Vrms)
 Input impedance: more than 47 kilohms

Audio output: LINE OUT
 Standard level: -7.5dBs at load impedance 47 kilohms
 Output impedance: less than 10 kilohms

2-1-6. Adjustment Sequence

The adjustments should be performed in the following sequence.

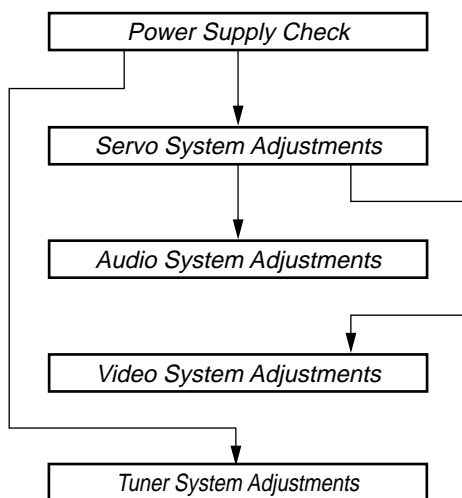

2-2. POWER SUPPLY CHECK

2-2-1. Output Voltage Check (MA-317 Board)

Mode	E-E
Measuring Instrument	Digital voltmeter
SW 12V Check	
Measurement point	IC601 pin ②
Specified value	12.0 ± 0.3V
MTR12V Check	
Measurement point	Q605 ③
Specified value	13.5 ± 1.0V
SW5V Check	
Measurement point	Q603 ⑤
Specified value	5.1 ± 0.3V

[Check Method]

- 1) Each of these supply voltages must meet its specified value.

2-3. SERVO SYSTEM CHECK

Unless otherwise specified, set the switches to the following positions.

- **PROGRAM** switch LINE or LINE 1
- **INPUT SELECT** switch LINE or LINE 1
(Remote commander)
- **TAPE SPEED** switch SP (Remote commander)

2-3-1. RF Switching Position/ AF Switching Position Adjustments (MA-317 Board)

[Adjustment Purpose]

To adjust the link of the A-ch and B-ch of the tape playback outputs. To make the unit compatible with other tapes and units. If this specification is not satisfied, the link will appear on the screen and the screen will be disrupted, etc.

Mode	Playback
Signal	Alignment tape: SP color bar portion
Measurement point	CH1: Video LINE OUT (RF switching position) CN341 pin ① (HF ADJ) (AF switching position) CH2: CN261 pin ③ (RF SWP)
Measuring instrument	Oscilloscope
Specified value	$6.5 \pm 0.5H$ ($410 \pm 32 \mu\text{sec}$)

[Adjustment Method]

- 1) Short-circuit between JS401 and ground for about 1 second to activate the RF switching position adjustment mode.
- 2) Check that "AP" is indicated on FL display.
- 3) Using the channel + and - buttons, adjust to $410 \pm 32 \mu\text{sec}$ ($6.5 \pm 0.5H$).
- 4) Press the PAUSE button. (Adjustment is over for mono models.)
- 5) The set goes to the AF switching position adjustment mode.
- 6) Check that "AH" is indicated on FL display.
- 7) Using the channel + and - buttons, minimize a chipped portion. At this time, confirm that a noisy sound is not heard.
- 8) Press the PAUSE button.
- 9) Check that "AH" indication is disappeared. When it is not disappeared, repeat from the item 1).
- 10) Press the STOP button.
- 11) Press the EJECT button.

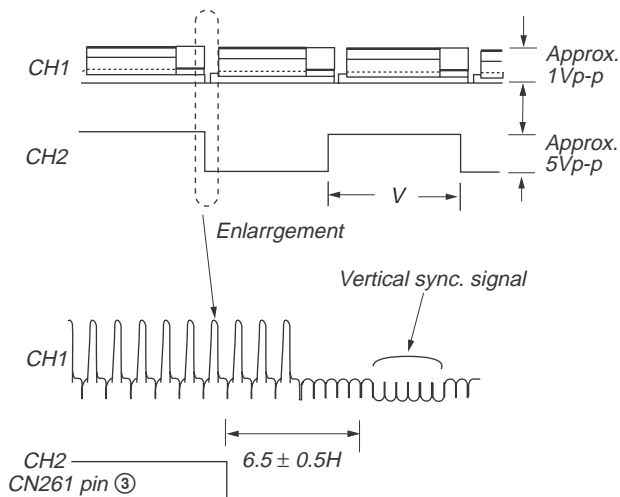

Fig. 6-2-3.

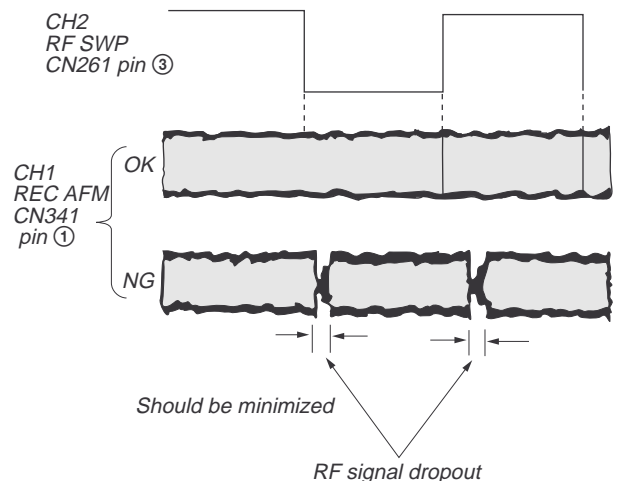

Fig. 6-2-4.

2-4. VIDEO SYSTEM CHECKS AND ADJUSTMENT

For the video system checks, follow the checking procedures given below as a rule. The color bar video signal supplied from the pattern generator is used as the video input signal for the video system adjustment of the recording mode. Check that the signal satisfies the specified value designated in the "Check of input signal" (Fig. 6-2-2)

Unless otherwise specified, set the switches to the following positions.

- **INPUT SELECT** switch LINE or LINE 1 (Remote commander)
- **TAPE SPEED** switch SP (Remote commander)

[Checking Sequence]

- 1) X'tal OSC Check
- 2) SYNC AGC Check
- 3) White clip/Dark clip Check
- 4) Recording Y Level Check
- 5) Recording Chroma Level Check
- 6) Playback Level Check
- 7) VCO frequency adjustment

2-4-1. X'tal OSC Check (MA-317 Board)

Mode	Playback
Signal	Alignment tape: SP Color bar portion
Measurement point	IC201 pin ⑤⑥
Measuring instrument	Oscilloscope and Frequency counter
Specified value	$3,579,545 \pm 70\text{Hz}$

Note: A frequency counter should be connected through a buffer amplifier (oscilloscope, etc.) having a high impedance and a low capacitance.

[Check Method]

- 1) Check that the oscillation frequency satisfies the specified value and that the oscillation voltage is $500 \pm 200\text{mVp-p}$.

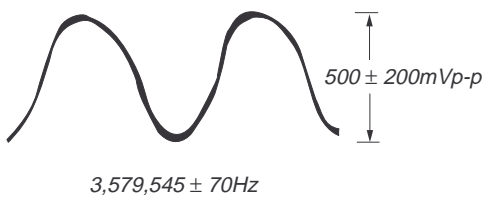

Fig. 6-2-5.

2-4-2. SYNC AGC Check (MA-317 Board)

Mode	E-E
Signal	Color bar
Measurement point	IC201 pin ③⑨
Measuring instrument	Oscilloscope
Specified value	$A=2.10 \pm 0.14\text{Vp-p}$

[Check Method]

- 1) Check that the Video signal level (A) satisfies the specified value.

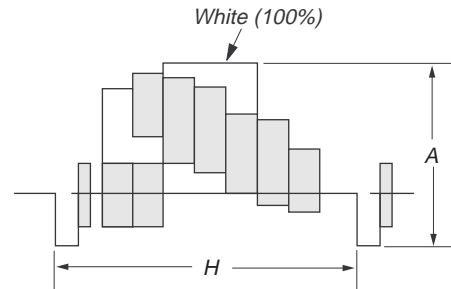

Fig. 6-2-6.

2-4-3. White Clip/Dark Clip Check (MA-317 Board)

Mode	E-E
Signal	Color bar
Measurement point	IC201 pin ③⑦
Measuring instrument	Oscilloscope
Specified value	White clip : $190 \pm 10\%$ Dark clip : $58.5 \pm 5\%$

Connect a resistor of $3.3\text{k}\Omega$ between IC201 pin ④② and GND.

[Check Method]

- 1) Check that the white clip level is $190 \pm 15\%$ to the white (100%) level.
- 2) Check that the dark chip level is $50 \pm 10\%$ to the white (100%) level.

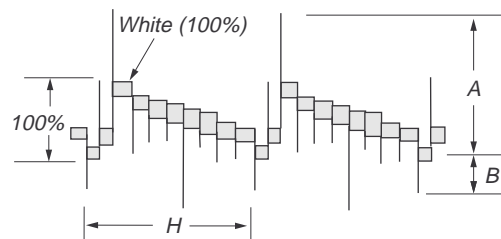

Fig. 6-2-7.

2-4-4. Recording Y Level Check (MA-317 Board)

Mode	E-E
Signal	No-signal
Measurement point	IC201 pin ⑩
Measuring instrument	Oscilloscope
Specified value	$A=290 \pm 70\text{mVp-p}$

[Check Method]

- 1) Check that the recording RF signal satisfies the specified value.

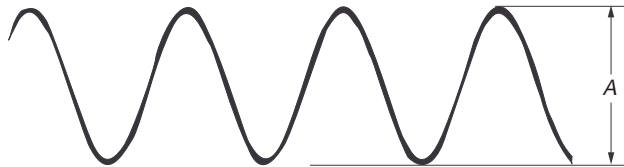

Fig. 6-2-8.

2-4-5. Recording Chroma Level Check (MA-317 Board)

Mode	Recording
Signal	Color bar
Measurement point	IC201 pin ⑩
Measuring instrument	Oscilloscope
Specified value	$A=450 \pm 70\text{mVp-p}$

[Check Method]

- 1) Confirm the amplitude of recording chroma level becomes the specified value.

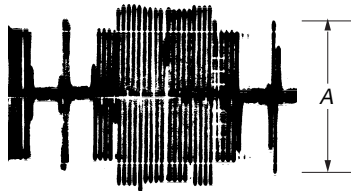

Fig. 6-2-9.

2-4-6. Playback Level Check (MA-317 Board)

Mode	Playback
Signal Alignment	Alignment tape : SP mode color bar portion
Measurement point	Video LINE OUT terminal
Measuring instrument	Oscilloscope
Specified value	$A=1.0 \pm 0.1\text{Vp-p}$ (75Ω terminated)

[Check Method]

- 1) Check that the playback level satisfies the specified value.

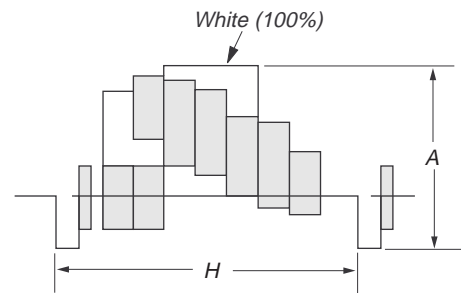

Fig. 6-2-10.

2-5. AUDIO SYSTEM ADJUSTMENT

- For the adjustment of the audio system, perform in the SP mode if there is no special notes. Use the alignment tape.

[Connecting Instruments]

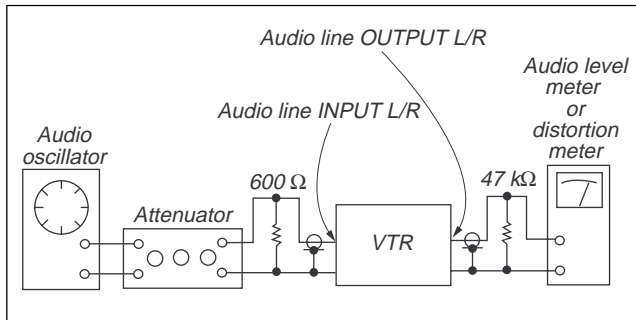

Fig. 6-2-12.

- Adjust in the SP mode if there is no special indications.
- Perform the adjustment setting the switch on the following positions.
- INPUT SELECT** switch LINE or LINE 1 (Remote commander)

[Adjustment Method]

- ACE head adjustment.....Refer to the VHS mechanical adjustment manual VI (S MECHANISM)(9-921-647-11).
- E-E output level check
- Overall Output level and distortion factor check
- Overall noise level check.

2-5-1. ACE Head Adjustment

Refer to the VHS mechanical adjustment manual VI (S MECHANISM)(9-921-647-11).

2-5-2. E-E Output Level Check

Mode	E-E
Signal	400Hz, -7.5dBs : CJ570
Measurement point	CJ570
Measuring instrument	Audio level meter
Specified value	-7.5 ± 2dBs

[Check Method]

- Input signal of 400Hz and -7.5dBs to the CJ461 L/R.
- Check that the audio output level is -7.5 ± 3dBs.

2-5-3. Overall Output Level and Distortion Factor Check

Mode	Self-record playback
Signal	400Hz, -7.5dBs : CJ570
Measurement point	CJ570
Measuring instrument	Audio level meter and Distortion meter
Specified value	Playback Level: -7.5 ± 3dBs Distortion: 4.0% or less

[Check Method]

- Input signal of 400Hz and -7.5dBs to the audio input.
- Record signal.
- Playback the recorded portion.
- Check that the output level is -7.5 ± 3dBs.
- Check that the distortion factor is 4.0% or less.

2-5-4. Overall Noise Level Check

Mode	Self-record playback
Signal	No signal (Insert a shorting plug into the Audio LINE IN terminal)
Measurement point	CJ570
Measuring instrument	Audio level meter
Specified value	-45.5dBs or less

[Check Method]

- Record.
- Playback recorded portion.
- Check that noise level is -45.5dBs or less.

2-6. TUNER SYSTEM ADJUSTMENT (HiFi MODEL)

2-6-1. Separation Adjustment (MA-317 Board)

Mode	E-E
Signal	RF signal Video : Color bar white (100%) modulation Audio : L: 400Hz, R: 2kHz 30% modulation Electrical field: 60-80dBm/75Ω terminated
Measuring instrument	Audio level meter
Measuring point	LINE OUT L
Adjusting element	RV731
Specified value	2kHz component minimum

[Adjustment Method]

- Connect an audio level meter to LINE OUT L channel via HPF.
- Feed the RF signal from RF IN terminal.
- Adjust with RV731 so that the output level satisfies the specified value.

2-7. ADJUSTING PARTS LOCATION DIAGRAM
MA-317 BOARD (CONDUCTOR SIDE)

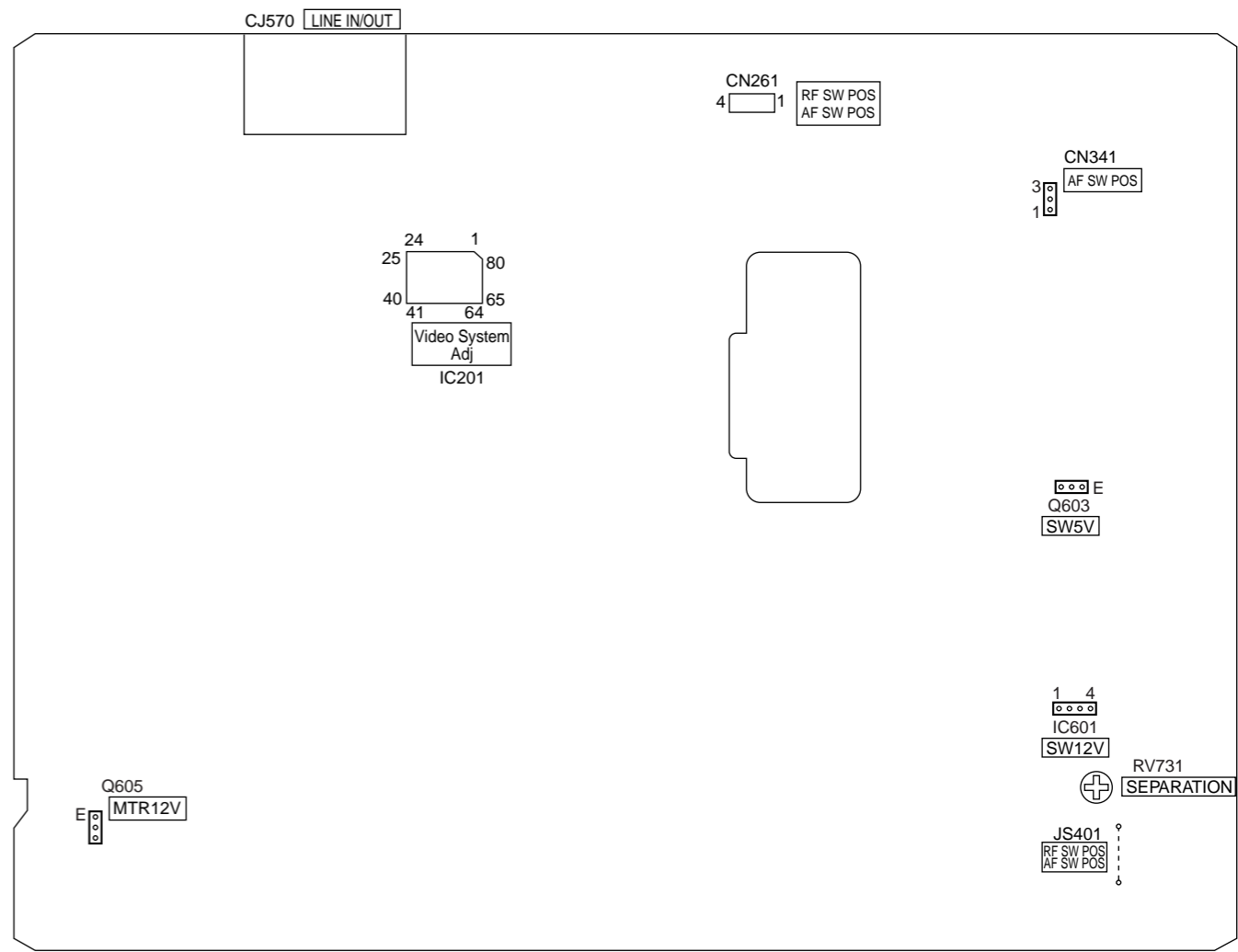

SECTION 7
REPAIR PARTS LIST

7-1. EXPLODED VIEWS

Note:

- -XX, -X mean standardized parts, so they may have some differences from the original one.
- Items marked “*” are not stocked since they are seldom required for routine service. Some delay should be anticipated when ordering these items.
- The mechanical parts with no reference number in the exploded views are not supplied.
- Hardware (#mark) list is given in the last of this parts list.

The components identified by mark \triangle or dotted line with mark \triangle are critical for safety. Replace only with part number specified.

Les composants identifiés par une marque \triangle sont critiques pour la sécurité. Ne les remplacer que par une pièce portant le numéro spécifié.

7-1-1. FRONT PANEL ASSEMBLY AND UPPER CASE SECTION

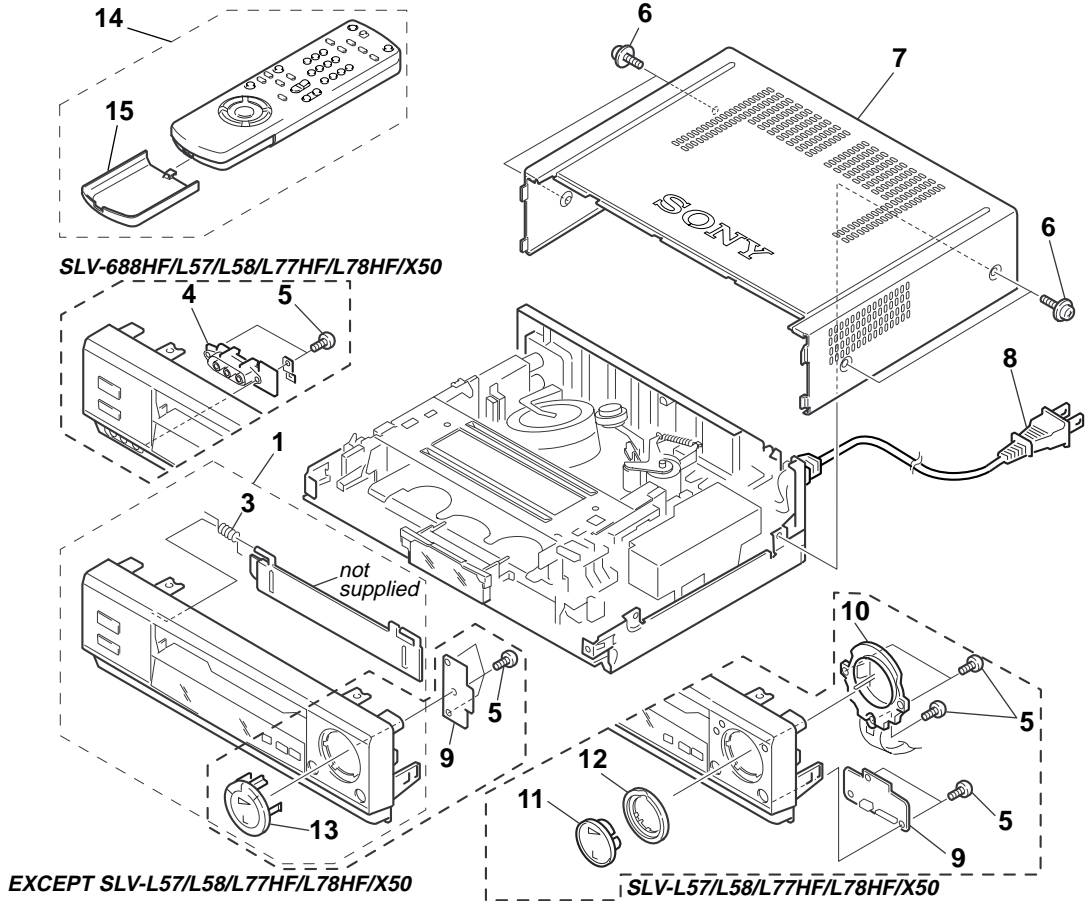

Ref. No.	Part No.	Description	Remarks	Ref. No.	Part No.	Description	Remarks
1	X-3948-006-1	PANEL ASSY, FRONT (478)		* 9	A-6794-482-A	DS-79S BOARD, COMPLETE (478,677HF,678HF,688HF)	
1	X-3948-007-1	PANEL ASSY, FRONT (678HF)		* 9	A-6794-503-A	DS-79SX BOARD, COMPLETE (L47,L48,L67HFPA,L68HF,X60HF)	
1	X-3948-008-1	PANEL ASSY, FRONT (688HF)		* 9	A-6794-509-A	DS-79D BOARD, COMPLETE (L57,L58,L77HF,L78HF,X50)	
1	X-3948-009-1	PANEL ASSY, FRONT (L47)		10	1-762-844-21	SWITCH, ROTARY (L57,L58,L77HF,L78HF,X50)	
1	X-3948-010-1	PANEL ASSY, FRONT (L57)		11	3-972-782-11	BUTTON, CENTER (L57,L77HF)	
1	X-3948-011-1	PANEL ASSY, FRONT (L67HF)		11	3-972-782-61	BUTTON, CENTER (L58,L78HF,X50)	
1	X-3948-012-1	PANEL ASSY, FRONT (L77HF)		12	3-979-480-01	RING, BP JOG (L58,L78HF,X50)	
1	X-3948-013-1	PANEL ASSY, FRONT (L78HF)		12	3-979-480-11	RING, BP JOG (L57,L77HF)	
1	X-3948-014-1	PANEL ASSY, FRONT (L68HF)		13	X-3946-598-1	BUTTON ASSY, FUNCTION (677HF)	
1	X-3948-015-1	PANEL ASSY, FRONT (L58)		13	X-3948-060-1	BUTTON ASSY, FUNCTION (L48,L68HF,X60HF)	
1	X-3948-016-1	PANEL ASSY, FRONT (L48)		13	X-3948-061-1	BUTTON ASSY, FUNCTION (L47,L67HF)	
1	X-3948-036-1	PANEL ASSY, FRONT (677HF)		14	1-475-552-11	COMMANDER, STANDARD (RMT-V230) (L47,L48)	
1	X-3948-037-1	PANEL ASSY, FRONT (X60HF)		14	1-475-553-11	COMMANDER, STANDARD (RMT-V231) (L67HF,L68HF,X60HF)	
1	X-3948-038-1	PANEL ASSY, FRONT (X50)		14	1-475-553-21	COMMANDER, STANDARD (RMT-V231A) (478,677HF,678HF)	
3	3-953-432-01	SPRING (GE), FL		14	1-475-553-31	COMMANDER, STANDARD (RMT-V231B) (688HF)	
* 4	A-6794-483-A	JK-161 BOARD, COMPLETE (688HF)		14	1-475-554-11	COMMANDER, STANDARD (RMT-V232) (L57,L58,L77HF,L78HF,X50)	
* 4	A-6794-508-A	JK-161MX BOARD, COMPLETE (L57,L58,X50)		15	3-709-128-01	COVER, BATTERY (478,677HF,678HF,L67HF,L68HF,X60HF)	
* 4	A-6794-510-A	JK-161HX BOARD, COMPLETE (L77HF,L78HF)		15	3-709-129-01	COVER, BATTERY (L57,L58,L77HF,L78HF)	
5	4-921-277-41	SCREW (B2.6X8), TAPPING, BIND		15	3-709-133-01	COVER, BATTERY (L47,L48)	
6	3-710-901-11	SCREW, TAPPING					
* 7	3-988-080-21	CASE, UPPER (478,677HF,678HF,688HF)					
* 7	3-988-080-31	CASE, UPPER (EXCEPT 478,677HF,678HF,688HF)					
\triangle 8	1-777-851-41	CORD, POWER (478,677HF,678HF,688HF)					
\triangle 8	1-777-854-41	CORD, POWER (EXCEPT 478,677HF,678HF,688HF)					

7-1-2. CHASSIS SECTION

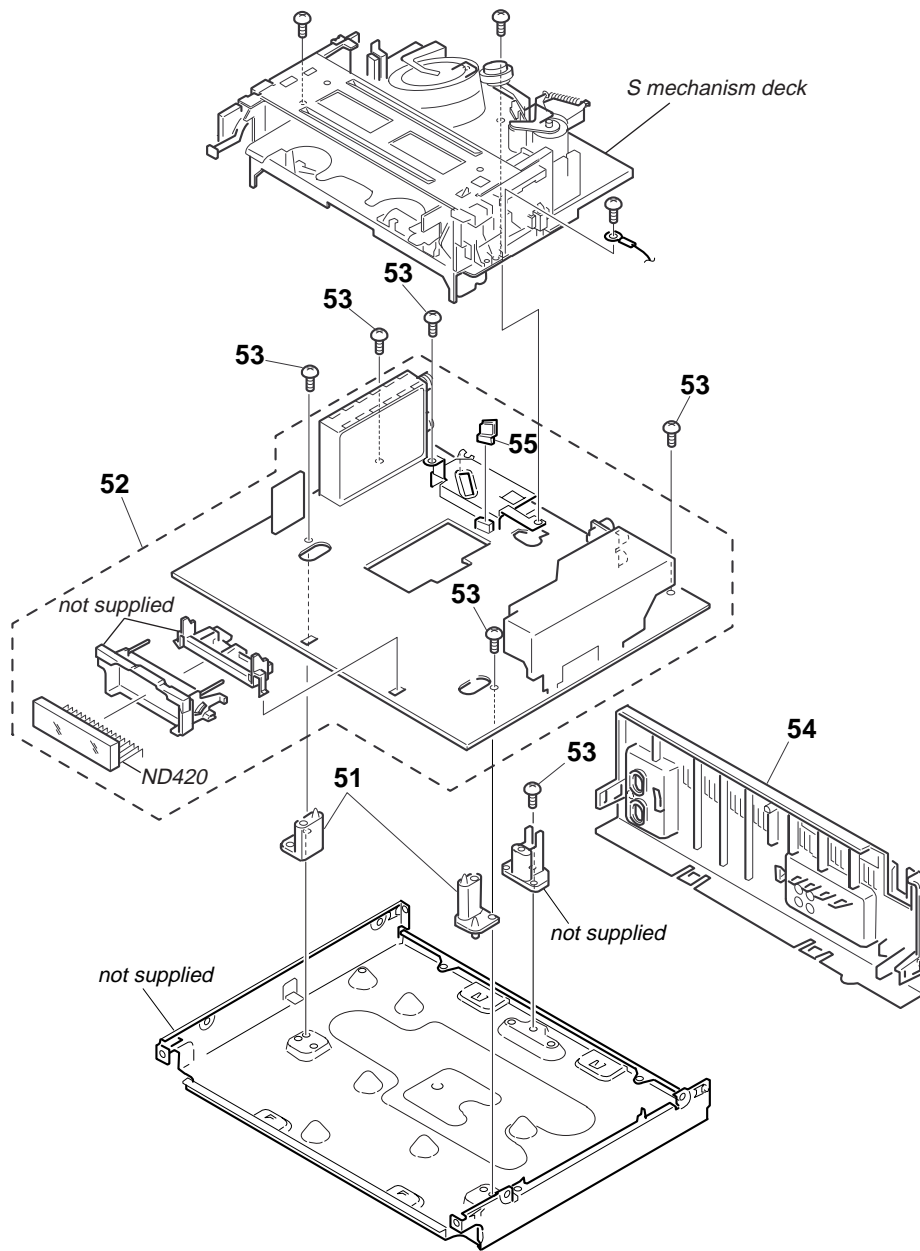

Ref. No.	Part No.	Description	Remarks	Ref. No.	Part No.	Description	Remarks
* 51	3-959-383-01	BASE (R), MD		53	3-970-608-21	SUMITITE (B3), +BV	
* 52	A-6791-430-A	MA-317A BOARD, COMPLETE (688HF)		* 54	3-979-652-01	PANEL (M), REAR (688HF)	
* 52	A-6791-438-A	MA-317G BOARD, COMPLETE (L47,L48)		* 54	3-979-652-11	PANEL (M), REAR (677HF,678HF)	
* 52	A-6791-445-A	MA-317E BOARD, COMPLETE (L67HF,L68HF,X60HF)		* 54	3-979-652-31	PANEL (M), REAR (478)	
* 52	A-6791-447-A	MA-317F BOARD, COMPLETE (L57,L58,X50)		* 54	3-987-076-01	PANEL, REAR (L67HF,L68HF,L77HF,L78HF,X60HF)	
* 52	A-6791-448-A	MA-317D BOARD, COMPLETE (L77HF,L78HF)		* 54	3-987-076-11	PANEL, REAR (L47,L48,L57,L58,X50)	
* 52	A-6791-456-A	MA-317B BOARD, COMPLETE (677HF,678HF)		55	1-779-725-11	CONNECTOR, BOARD TO BOARD 5P	
* 52	A-6791-458-A	MA-317C BOARD, COMPLETE (478)		ND420	1-517-732-11	TUBE, FLUORESCENT INDICATOR	

7-1-3. MECHANISM DECK-1

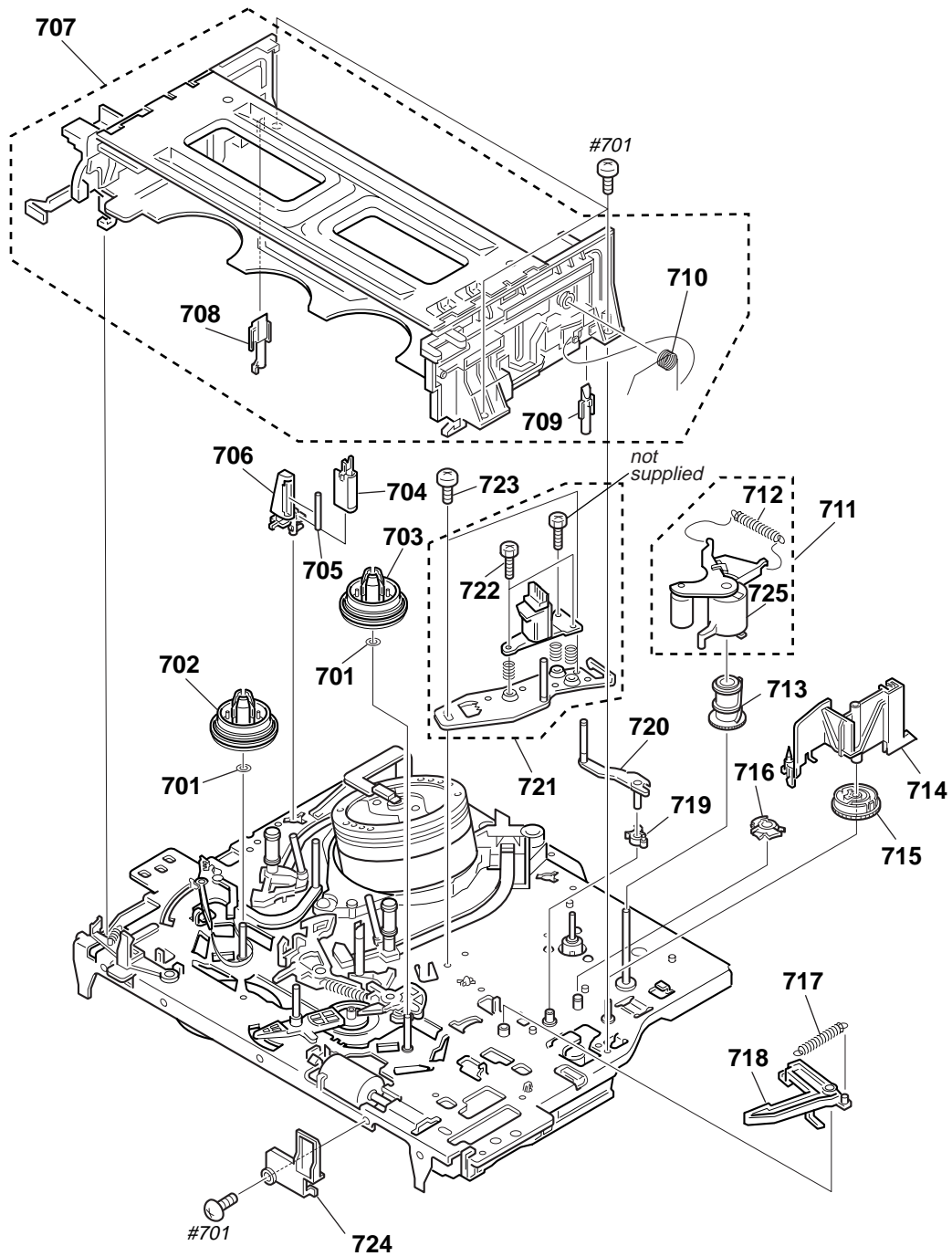

Ref. No.	Part No.	Description	Remarks	Ref. No.	Part No.	Description	Remarks
701	3-977-509-01	WASHER, THRUST		714	3-977-514-01	OPENER, LID	
702	3-977-507-01	TABLE, REEL (S) (GRAY)		715	3-977-441-01	GEAR, PINCH PRESSING	
703	3-977-508-01	TABLE, REEL (T) (BLACK)		716	3-977-445-01	GEAR, TG8 ARM DRIVING	
704	1-500-144-11	HEAD, FE		717	3-977-465-01	SPRING, EXTENSION (RVS BRAKE)	
705	3-977-495-01	SHAFT TG2		718	X-3947-582-1	ARM ASSY, RVS BRAKE	
706	3-977-494-01	HOLDER, FEH		719	3-977-446-01	GEAR, TG8 ARM	
707	A-6759-619-C	FL COMPLETE ASSY		720	X-3947-590-1	TG8 ASSY	
708	3-977-535-01	PLATE, LUMINOUS (END SENSOR)		721	A-6759-620-A	HEAD BLOCK ASSY, ACE (TKD)	
709	3-977-536-01	PLATE, LUMINOUS (TOP SENSOR)		722	3-974-556-01	+ HEXA TT 2.6X9 (TAPER)	
710	3-970-471-01	SPRING (DECK OPEN), TORSION		723	3-979-508-01	SCREW	
711	A-6759-615-A	PRESS BLOCK ASSY, PINCH		724	3-978-485-01	PLATE, GUIDE CASSETTE	
712	3-958-455-01	SPRING (PINCH), TENSION		725	X-3946-870-1	ARM ASSY, PINCH ROLLER	
713	3-977-447-01	GEAR, ELEVATOR					

7-1-4. MECHANISM DECK-2

Note: There are two types of drum assembly in the HiFi models for service.

[Discrimination]

No. 768-770
—Top View—

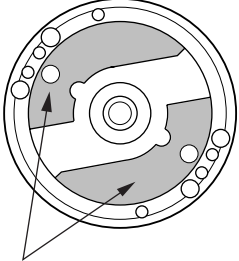

There are two printed circuit boards on the top.

No. 776
—Top View—

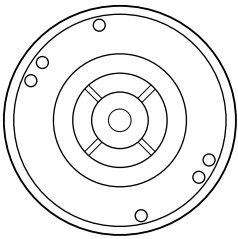

There is no printed circuit board.

Note: It cannot be divided to two parts, the upper and the lower drum assemblies.

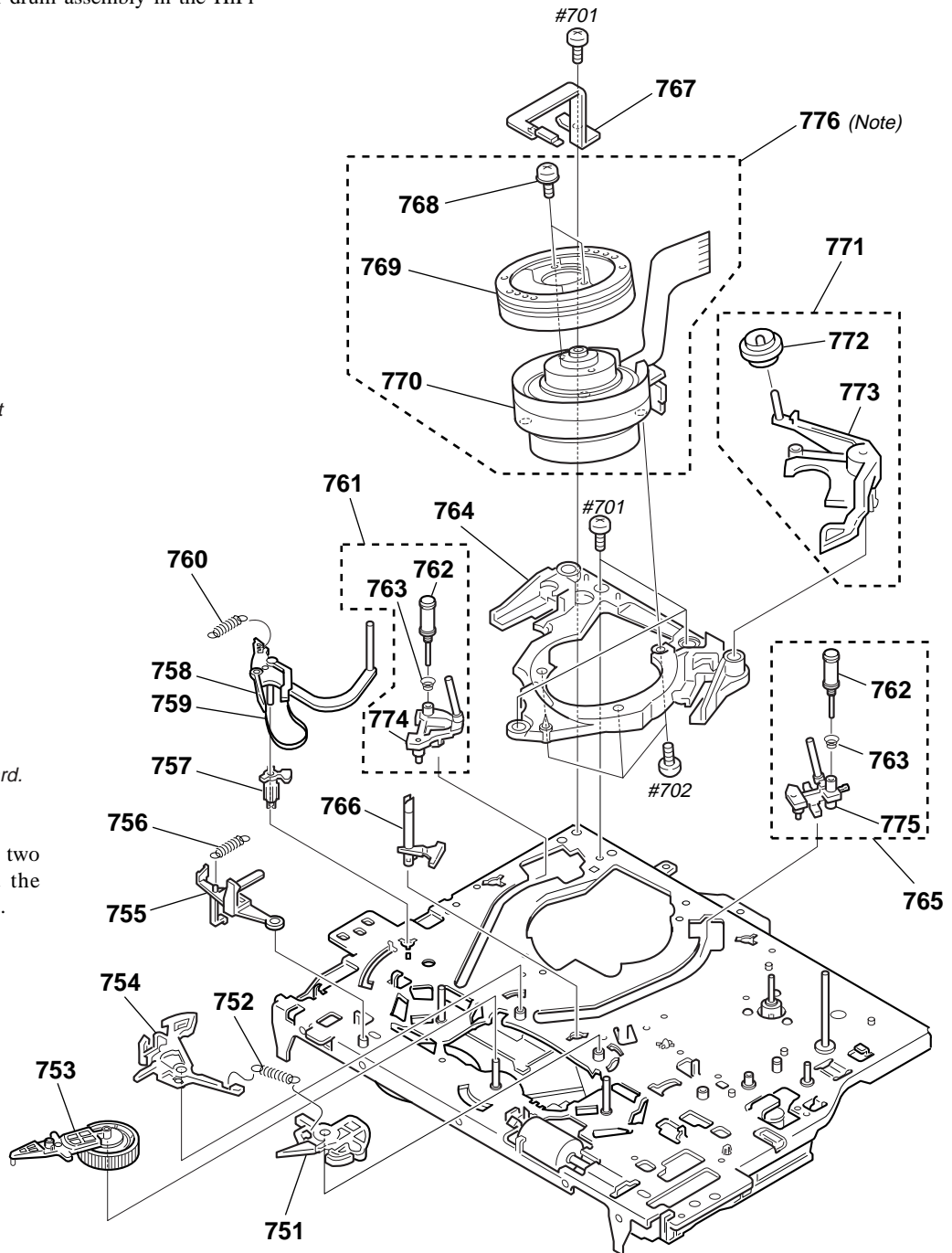

Ref. No.	Part No.	Description	Remarks	Ref. No.	Part No.	Description	Remarks
751	X-3947-581-1	BRAKE ASSY,MAIN(T)		765	A-6750-325-A	SHUTTLE (T) BLOCK ASSY	
752	3-977-462-01	SPRING,EXTENTION. (MAIN BRAKE)		766	3-977-501-01	PLATE, LUMINOUS	
753	X-3947-573-1	ARM ASSY, PENDULUM		767	X-3943-899-8	GROUND ASSY, SHAFT	
754	X-3947-580-2	BRAKE ASSY, MAIN(S)		768	2-643-205-01	SCREW	
755	3-977-513-02	LEVER, REC. PROOF		769	8-848-576-02	DRUM ASSY, UPPER DZR-45-R (HiFi)(Note)	
756	3-976-767-01	SPRING, TENS. (REC. PROOF)		770	8-848-666-11	DRUM ASSY, LOWER DZL-51B/J-RP (M901) (HiFi)	
757	3-977-487-01	BOSS, TG1 FULCRUM		771	A-6746-074-G	ROLLER BLOCK ASSY, HC	
758	X-3947-587-1	TG1 ASSY		772	X-3947-255-1	ROLLER ASSY, HC	
759	X-3947-589-1	BAND ASSY, TG1		773	3-975-724-07	ARM, HC	
760	3-977-488-01	SPRING (POWER TENSION)		774	X-3946-855-1	SHUTTLE (S) ASSY	
761	A-6750-324-A	SHUTTLE (S) BLOCK ASSY		775	X-3946-856-1	SHUTTLE (T) ASSY	
762	X-3944-378-1	ROLLER ASSY, GUIDE		776	8-839-036-04	DRUM ASSY DZH-73D-ZRB (M901)(MONO)	
763	3-965-178-01	SPRING		776	8-839-044-02	DRUM ASSY DZH-94A/Z-RP (M901)(HiFi)(Note)	
764	3-969-629-01	BASE, DRUM					

7-1-5. MECHANISM DECK-3

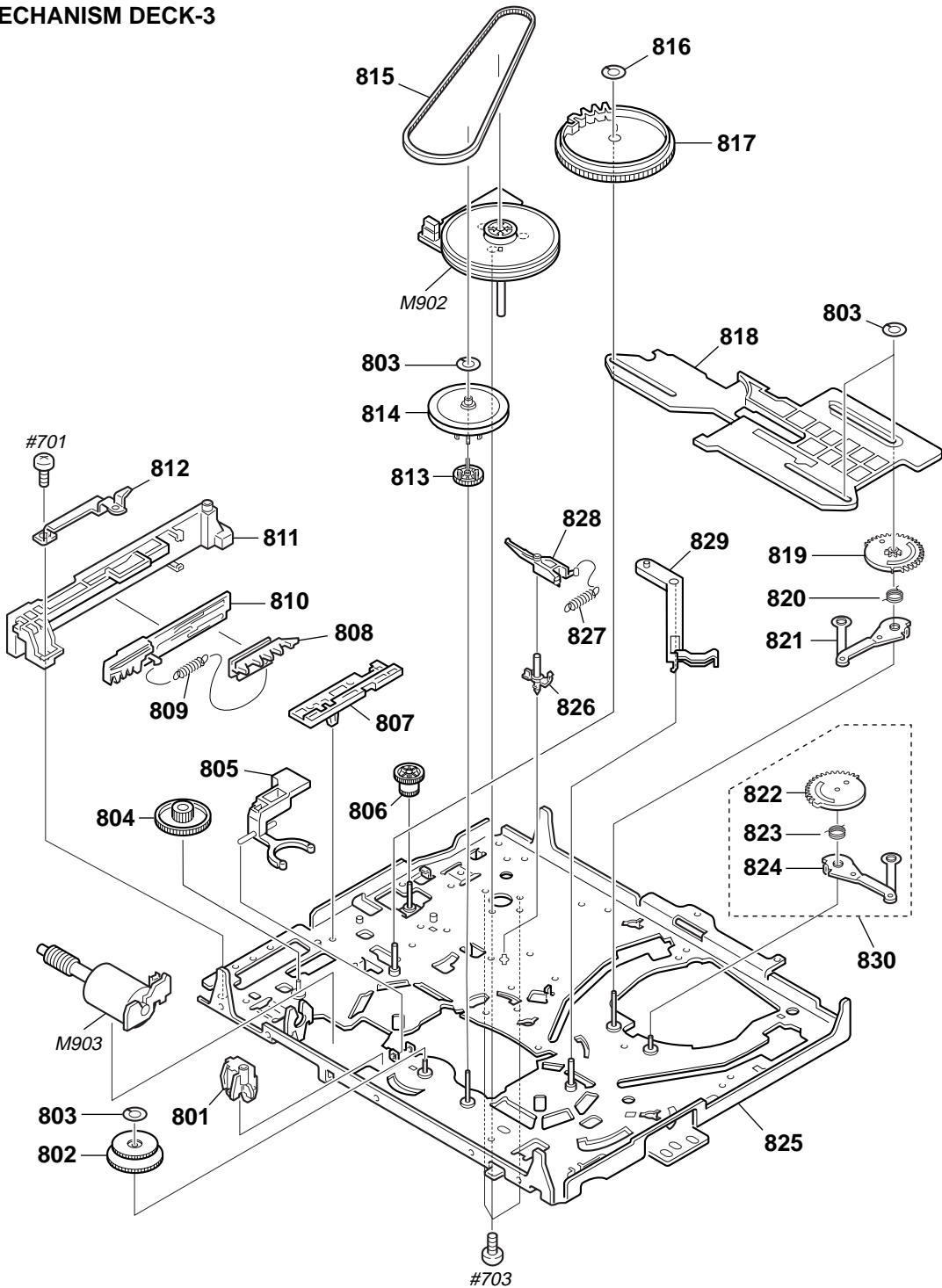

Ref. No.	Part No.	Description	Remarks	Ref. No.	Part No.	Description	Remarks
801	3-977-437-01	RETAINER, CAM MOTOR		817	3-977-439-01	GEAR, CAM	
802	X-3947-584-1	ASSY, REEL DIRECT		818	3-977-442-01	SLIDER	
803	3-977-443-01	WASHER, STOPPER		819	3-977-455-01	GEAR, LOADING(T)	
804	3-977-438-01	WORM - WHEEL		820	3-977-456-03	SPRING, TORSION (LOAD T)	
805	3-977-506-01	ARM, LIMITTER SELECTION		821	X-3947-579-1	LEVER ASSY, LOADING(T)	
806	3-977-444-01	GEAR, PINCH TRANSMISSION		822	3-977-451-01	GEAR, LOADING(S)	
807	3-977-515-01	GUIDE, FL SLIDER		823	3-977-452-01	SPRING, TORSION (LOAD S)	
808	3-977-517-01	PLATE, SLIDE, FL		824	X-3947-578-1	LEVER ASSY, LOADING(S)	
809	3-977-519-01	SPRING, TENS. (LIMIT, FL)		825	X-3947-576-2	CHASSIS ASSY, MECHANICAL	
810	3-977-518-02	PLATE, LIMITTER, FL		826	3-977-468-01	SHAFT, CAPSTAN BRAKE	
811	3-977-516-01	HOLDER, FL SLIDER		827	3-977-467-02	SPRING, CAP BRAKE	
812	3-977-877-01	PLATE, RETAINER		828	X-3947-583-1	BRAKE ASSY, CAPSTAN	
813	3-977-504-01	GEAR, CLUTCH		829	3-977-489-01	ARM, TG1 DRIVING	
814	X-3947-585-1	GEAR ASSY, PULLEY		830	A-6759-616-A	GEAR BLOCK ASSY, LOADING	
815	3-977-510-01	BELT, RUBBER		M902	1-698-971-11	MOTOR, DC	
816	3-977-440-01	WASHER, STOPPER		M903	X-3947-577-1	MOTOR ASSY, CAM	

7-2. ELECTRICAL PARTS LIST

Note:

When indicating parts by reference number, please include the board name.

The components identified by mark Δ or dotted line with mark Δ are critical for safety. Replace only with part number specified.

Les composants identifiés par une marque Δ sont critiques pour la sécurité. Ne les remplacer que par une pièce portant le numéro spécifié.

- Due to standardization, replacements in the parts list may be different from the parts specified in the diagrams or the components used on the set.
- -XX, -X mean standardized parts, so they may have some difference from the original one.
- Items marked "*" are not stocked since they are seldom required for routine service. Some delay should be anticipated when ordering these items.
- CAPACITORS:
uF: μ F
- RESISTORS
All resistors are in ohms.
METAL: metal-film resistor
METAL OXIDE: Metal Oxide-film resistor
F: nonflammable
- COILS
uH: μ H
- SEMICONDUCTORS
In each case, u: μ , for example:
uA...: μ A..., uPA..., μ PA... ,
uPB..., μ PB..., uPC..., μ PC... ,
uPD..., μ PD...

Ref. No.	Part No.	Description	Remarks
*	A-6794-482-A	DS-79S BOARD, COMPLETE ***** (478,677HF,678HF,688HF)	
*	A-6794-503-A	DS-79SX BOARD, COMPLETE ***** (L47,L48,L67HF,L68HF,X60HF)	
*	A-6794-509-A	DS-79D BOARD, COMPLETE ***** (L57,L58,L77HF,L78HF,X50) (Ref.No.:1,000 Series)	
		< CONNECTOR >	
CN442	1-774-471-41	CONNECTOR, FFC/FPC 5P (L57,L58,L77HF,L78HF,X50)	
		< DIODE >	
D441	8-719-056-06	DIODE SLR-342DCT31 (L57,L58,L77HF,L78HF,X50)	
		< JUMPER RESISTOR >	
JR702	1-216-296-00	METAL CHIP 0 5% 1/8W	
JR703	1-216-296-00	METAL CHIP 0 5% 1/8W	
JR704	1-216-296-00	METAL CHIP 0 5% 1/8W	
JR705	1-216-296-00	METAL CHIP 0 5% 1/8W	
JR706	1-216-295-00	METAL CHIP 0 5% 1/10W	
JR707	1-216-295-00	METAL CHIP 0 5% 1/10W	
JR708	1-216-296-00	METAL CHIP 0 5% 1/8W	
JR709	1-216-296-00	METAL CHIP 0 5% 1/8W	
		< RESISTOR >	
R451	1-216-053-00	METAL CHIP 1.5K 5% 1/10W	
R452	1-216-053-00	METAL CHIP 1.5K 5% 1/10W	
R454	1-216-037-00	METAL CHIP 330 5% 1/10W (L57,L58,L77HF,L78HF,X50)	
		< SWITCH >	
S441	1-571-977-11	SWITCH, TACTIL (FF) (L57,L58,L77HF,L78HF,X50)	
S442	1-571-977-11	SWITCH, TACTIL (PLAY) (EXCEPT L57,L58,L77HF,L78HF,X50)	
S443	1-571-977-11	SWITCH, TACTIL (STOP) (EXCEPT L57,L58,L77HF,L78HF,X50)	
S444	1-571-977-11	SWITCH, TACTIL (REW) (EXCEPT L57,L58,L77HF,L78HF,X50)	
S445	1-571-977-11	SWITCH, TACTIL (JOG) (L57,L58,L77HF,L78HF,X50)	

Ref. No.	Part No.	Description	Remarks
S446	1-571-977-11	SWITCH, TACTIL (FF) (EXCEPT L57,L58,L77HF,L78HF,X50)	
S447	1-571-977-11	SWITCH, TACTIL (REW) (L57,L58,L77HF,L78HF,X50)	
*	A-6794-483-A	JK-161 BOARD, COMPLETE (688HF) *****	
*	A-6794-508-A	JK-161MX BOARD, COMPLETE (L57,L58,X50) *****	
*	A-6794-510-A	JK-161HX BOARD, COMPLETE (L77HF,L78HF) ***** (Ref.No.:2,000 Series)	
		< CAPACITOR >	
C803	1-163-009-11	CERAMIC CHIP 0.001uF 10% 50V (688HF,L57,L58,L77HF,L78HF,X50)	
C805	1-163-009-11	CERAMIC CHIP 0.001uF 10% 50V (688HF,L77HF,L78HF)	
C806	1-163-009-11	CERAMIC CHIP 0.001uF 10% 50V (688HF,L57,L58,L77HF,L78HF,X50)	
		< PIN JACK >	
CJ801	1-774-509-11	JACK, PIN 3P (LINE 2 IN) (688HF,L77HF,L78HF)	
CJ801	1-774-510-11	JACK, PIN 2P (LINE 2 IN) (L57,L58,X50)	
		< CONNECTOR >	
CN801	1-506-469-11	PIN, CONNECTOR 4P (L57,L58,X50)	
CN801	1-506-470-11	PIN, CONNECTOR 5P (688HF,L77HF,L78HF)	
		< DIODE >	
D801	8-719-110-08	DIODE RD8.2ES-B2 (688HF,L57,L58,L77HF,L78HF,X50)	
D802	8-719-110-08	DIODE RD8.2ES-B2 (688HF,L77HF,L78HF)	
D803	8-719-109-84	DIODE RD5.1ES-B1 (688HF,L57,L58,L77HF,L78HF,X50)	
D804	8-719-110-08	DIODE RD8.2ES-B2 (688HF,L57,L58,L77HF,L78HF,X50)	
D805	8-719-110-08	DIODE RD8.2ES-B2 (688HF,L57,L58,L77HF,L78HF,X50)	
D806	8-719-110-08	DIODE RD8.2ES-B2 (688HF,L77HF,L78HF)	
D807	8-719-110-08	DIODE RD8.2ES-B2 (688HF,L57,L58,L77HF,L78HF,X50)	
		< JUMPER RESISTOR >	
JS801	1-216-295-00	METAL CHIP 0 5% 1/10W (L57,L58,X50)	

Ref. No.	Part No.	Description	Remarks	Ref. No.	Part No.	Description	Remarks
		< RESISTOR >					
R801	1-216-295-00	METAL CHIP 0 5% 1/10W (688HF,L57,L58,L77HF,L78HF,X50)		C172	1-163-259-91	CERAMIC CHIP 220PF 5% 50V	
R802	1-216-295-00	METAL CHIP 0 5% 1/10W (688HF,L77HF,L78HF)		C174	1-163-007-11	CERAMIC CHIP 680PF 10% 50V	
R803	1-216-022-00	METAL CHIP 75 5% 1/10W (688HF,L57,L58,L77HF,L78HF,X50)		C175	1-126-935-11	ELECT 470uF 20% 6.3V	
				C176	1-128-131-11	ELECT 22uF 20% 50V	
				C177	1-163-009-11	CERAMIC CHIP 0.001uF 10% 50V	
				C178	1-128-131-11	ELECT 22uF 20% 50V	
				C179	1-128-131-11	ELECT 22uF 20% 50V	
				C180	1-163-037-11	CERAMIC CHIP 0.022uF 10% 25V	
				C181	1-163-038-00	CERAMIC CHIP 0.1uF 25V	
				C182	1-126-933-11	ELECT 100uF 20% 16V	
*	A-6791-430-A	MA-317A BOARD, COMPLETE (688HF) *****		C183	1-104-760-11	CERAMIC CHIP 0.047uF 10% 50V	
*	A-6791-438-A	MA-317G BOARD, COMPLETE (L47,L48) *****		C184	1-104-760-11	CERAMIC CHIP 0.047uF 10% 50V	
*	A-6791-445-A	MA-317E BOARD, COMPLETE ***** (L67HF,L68HF,X60HF)		C185	1-164-004-11	CERAMIC CHIP 0.1uF 10% 25V	
*	A-6791-447-A	MA-317F BOARD, COMPLETE (L57,L58,X50) *****		C201	1-109-982-11	CERAMIC CHIP 1uF 10% 10V	
*	A-6791-448-A	MA-317D BOARD, COMPLETE (L77HF,L78HF) *****		C202	1-163-809-11	CERAMIC CHIP 0.047uF 10% 25V	
*	A-6791-456-A	MA-317B BOARD, COMPLETE (677HF,678HF) *****		C204	1-164-232-11	CERAMIC CHIP 0.01uF 50V	
*	A-6791-458-A	MA-317C BOARD, COMPLETE (478) ***** (Ref.No.:1,000 Series)		C205	1-163-037-11	CERAMIC CHIP 0.022uF 10% 25V	
*	3-960-273-01	SPACER, TOP END (478,677HF,678HF,688HF)		C206	1-164-232-11	CERAMIC CHIP 0.01uF 50V	
*	3-960-274-01	SPACER, LED (478,677HF,678HF,688HF)		C207	1-164-232-11	CERAMIC CHIP 0.01uF 50V	
*	3-966-865-01	BASE, INDICATION TUBE (478,677HF,678HF,688HF)		C208	1-163-243-11	CERAMIC CHIP 47PF 5% 50V	
	3-970-608-21	SUMITITE (B3), +BV		C209	1-124-248-00	ELECT 22uF 20% 35V	
		< CAPACITOR >		C210	1-163-131-00	CERAMIC CHIP 390PF 5% 50V	
C101	1-163-009-11	CERAMIC CHIP 0.001uF 10% 50V		C211	1-163-239-11	CERAMIC CHIP 33PF 5% 50V	
C102	1-163-009-11	CERAMIC CHIP 0.001uF 10% 50V		C213	1-163-257-11	CERAMIC CHIP 180PF 5% 50V	
C103	1-163-009-11	CERAMIC CHIP 0.001uF 10% 50V		C214	1-163-235-11	CERAMIC CHIP 22PF 5% 50V	
C104	1-163-009-11	CERAMIC CHIP 0.001uF 10% 50V		C217	1-109-982-11	CERAMIC CHIP 1uF 10% 10V	
C105	1-128-057-11	ELECT 330uF 20% 6.3V		C219	1-163-038-00	CERAMIC CHIP 0.1uF 25V	
C106	1-124-589-11	ELECT 47uF 20% 16V		C220	1-164-505-11	CERAMIC CHIP 2.2uF 16V	
C107	1-109-982-11	CERAMIC CHIP 1uF 10% 10V		C222	1-163-038-00	CERAMIC CHIP 0.1uF 25V (688HF,L57,L58,L77HF,L78HF,X50)	
C108	1-164-004-11	CERAMIC CHIP 0.1uF 10% 25V		C223	1-124-589-11	ELECT 47uF 20% 16V	
C109	1-164-004-11	CERAMIC CHIP 0.1uF 10% 25V		C226	1-163-038-00	CERAMIC CHIP 0.1uF 25V	
C111	1-164-232-11	CERAMIC CHIP 0.01uF 50V		C228	1-124-261-00	ELECT 10uF 20% 50V	
C112	1-164-232-11	CERAMIC CHIP 0.01uF 50V		C229	1-164-159-21	CERAMIC 0.1uF 50V	
C115	1-164-232-11	CERAMIC CHIP 0.01uF 50V		C230	1-124-589-11	ELECT 47uF 20% 16V	
C116	1-164-232-11	CERAMIC CHIP 0.01uF 50V		C231	1-124-261-00	ELECT 10uF 20% 50V	
C117	1-164-161-11	CERAMIC CHIP 0.0022uF 10% 100V		C232	1-109-982-11	CERAMIC CHIP 1uF 10% 10V	
C161	1-163-038-00	CERAMIC CHIP 0.1uF 25V		C233	1-109-982-11	CERAMIC CHIP 1uF 10% 10V	
C162	1-164-232-11	CERAMIC CHIP 0.01uF 50V		C234	1-164-232-11	CERAMIC CHIP 0.01uF 50V	
C163	1-164-232-11	CERAMIC CHIP 0.01uF 50V		C235	1-164-232-11	CERAMIC CHIP 0.01uF 50V	
C164	1-104-905-11	CAPACITOR 0.22F 5.5V		C236	1-109-982-11	CERAMIC CHIP 1uF 10% 10V	
C165	1-124-589-11	ELECT 47uF 20% 16V		C237	1-164-232-11	CERAMIC CHIP 0.01uF 50V	
C166	1-163-038-00	CERAMIC CHIP 0.1uF 25V		C238	1-164-159-21	CERAMIC 0.1uF 50V	
C167	1-163-229-11	CERAMIC CHIP 12PF 5% 50V		C240	1-109-982-11	CERAMIC CHIP 1uF 10% 10V	
C168	1-163-227-11	CERAMIC CHIP 10PF 0.5PF 50V		C241	1-163-037-11	CERAMIC CHIP 0.022uF 10% 25V	
C169	1-163-234-11	CERAMIC CHIP 20PF 5% 50V		C242	1-109-982-11	CERAMIC CHIP 1uF 10% 10V	
C170	1-163-234-11	CERAMIC CHIP 20PF 5% 50V		C243	1-164-232-11	CERAMIC CHIP 0.01uF 50V	
C171	1-163-809-11	CERAMIC CHIP 0.047uF 10% 25V		C245	1-163-809-11	CERAMIC CHIP 0.047uF 10% 25V	
				C246	1-109-982-11	CERAMIC CHIP 1uF 10% 10V	
				C247	1-163-809-11	CERAMIC CHIP 0.047uF 10% 25V	
				C248	1-164-232-11	CERAMIC CHIP 0.01uF 50V	
				C250	1-163-038-00	CERAMIC CHIP 0.1uF 25V	
				C251	1-163-038-00	CERAMIC CHIP 0.1uF 25V	
				C252	1-164-232-11	CERAMIC CHIP 0.01uF 50V	
				C253	1-164-004-11	CERAMIC CHIP 0.1uF 10% 25V	
				C254	1-163-038-00	CERAMIC CHIP 0.1uF 25V	
				C255	1-163-038-00	CERAMIC CHIP 0.1uF 25V	
				C256	1-163-038-00	CERAMIC CHIP 0.1uF 25V	
				C260	1-163-229-11	CERAMIC CHIP 12PF 5% 50V	
				C261	1-163-229-11	CERAMIC CHIP 12PF 5% 50V	

MA-317

Ref. No.	Part No.	Description	Remarks	Ref. No.	Part No.	Description	Remarks
C264	1-163-037-11	CERAMIC CHIP	0.022uF 10% 25V	C353	1-163-038-00	CERAMIC CHIP	0.1uF 25V
C265	1-163-037-11	CERAMIC CHIP	0.022uF 10% 25V				(HiFi)
C266	1-164-232-11	CERAMIC CHIP	0.01uF 50V	C357	1-163-009-11	CERAMIC CHIP	0.001uF 10% 50V
C267	1-163-037-11	CERAMIC CHIP	0.022uF 10% 25V				(HiFi)
C268	1-163-241-11	CERAMIC CHIP	39PF 5% 50V	C358	1-164-004-11	CERAMIC CHIP	0.1uF 10% 25V
							(HiFi)
C269	1-163-241-11	CERAMIC CHIP	39PF 5% 50V	C359	1-164-232-11	CERAMIC CHIP	0.01uF 50V
C270	1-163-037-11	CERAMIC CHIP	0.022uF 10% 25V				(HiFi)
C271	1-163-037-11	CERAMIC CHIP	0.022uF 10% 25V	C361	1-164-222-11	CERAMIC CHIP	0.22uF 25V
C272	1-163-241-11	CERAMIC CHIP	39PF 5% 50V				(HiFi)
C273	1-163-241-11	CERAMIC CHIP	39PF 5% 50V	C362	1-164-222-11	CERAMIC CHIP	0.22uF 25V
							(HiFi)
C274	1-163-037-11	CERAMIC CHIP	0.022uF 10% 25V	C363	1-126-960-11	ELECT	1uF 20% 50V
C276	1-163-037-11	CERAMIC CHIP	0.022uF 10% 25V				(HiFi)
C277	1-163-037-11	CERAMIC CHIP	0.022uF 10% 25V	C364	1-126-960-11	ELECT	1uF 20% 50V
C278	1-163-037-11	CERAMIC CHIP	0.022uF 10% 25V				(HiFi)
C279	1-163-037-11	CERAMIC CHIP	0.022uF 10% 25V	C365	1-126-960-11	ELECT	1uF 20% 50V
							(688HF,L77HF,L78HF)
C280	1-124-584-00	ELECT	100uF 20% 10V	C366	1-126-960-11	ELECT	1uF 20% 50V
C281	1-164-346-11	CERAMIC CHIP	1uF 16V				(688HF,L77HF,L78HF)
C282	1-164-232-11	CERAMIC CHIP	0.01uF 50V	C369	1-126-964-11	ELECT	10uF 20% 50V
C283	1-163-038-00	CERAMIC CHIP	0.1uF 25V				(HiFi)
C284	1-163-038-00	CERAMIC CHIP	0.1uF 25V	C370	1-126-964-11	ELECT	10uF 20% 50V
							(HiFi)
C286	1-124-584-00	ELECT	100uF 20% 10V	C371	1-126-964-11	ELECT	10uF 20% 50V
C287	1-163-227-11	CERAMIC CHIP	10PF 0.5PF 50V				(HiFi)
C288	1-163-227-11	CERAMIC CHIP	10PF 0.5PF 50V	C372	1-126-964-11	ELECT	10uF 20% 50V
C289	1-163-038-00	CERAMIC CHIP	0.1uF 25V				(HiFi)
C291	1-163-222-11	CERAMIC CHIP	5PF 0.25PF 50V	C373	1-126-964-11	ELECT	10uF 20% 50V
							(HiFi)
C292	1-163-038-00	CERAMIC CHIP	0.1uF 25V	C374	1-126-960-11	ELECT	1uF 20% 50V
C301	1-164-159-21	CERAMIC	0.1uF 50V				(HiFi)
C303	1-126-960-11	ELECT	1uF 20% 50V	C375	1-164-004-11	CERAMIC CHIP	0.1uF 10% 25V
			(MONO)				(HiFi)
C304	1-126-960-11	ELECT	1uF 20% 50V	C377	1-126-967-11	ELECT	47uF 20% 16V
			(L57,L58,X50)				(HiFi)
C306	1-126-960-11	ELECT	1uF 20% 50V	C378	1-126-964-11	ELECT	10uF 20% 50V
C307	1-126-964-11	ELECT	10uF 20% 50V				(HiFi)
C308	1-126-967-11	ELECT	47uF 20% 16V	C379	1-126-961-11	ELECT	2.2uF 20% 50V
C309	1-126-963-11	ELECT	4.7uF 20% 50V				(HiFi)
C310	1-163-009-11	CERAMIC CHIP	0.001uF 10% 50V	C380	1-124-261-00	ELECT	10uF 20% 50V
							(HiFi)
C311	1-163-014-00	CERAMIC CHIP	0.0027uF 10% 50V	C381	1-126-967-11	ELECT	47uF 20% 16V
C312	1-164-232-11	CERAMIC CHIP	0.01uF 50V				(HiFi)
C313	1-126-964-11	ELECT	10uF 20% 50V	C383	1-164-004-11	CERAMIC CHIP	0.1uF 10% 25V
C314	1-164-232-11	CERAMIC CHIP	0.01uF 50V				(HiFi)
C315	1-126-960-11	ELECT	1uF 20% 50V	C384	1-164-232-11	CERAMIC CHIP	0.01uF 50V
							(HiFi)
C317	1-126-163-11	ELECT	4.7uF 20% 50V	C385	1-126-967-11	ELECT	47uF 20% 16V
C318	1-126-967-11	ELECT	47uF 20% 16V				(HiFi)
C331	1-164-232-11	CERAMIC CHIP	0.01uF 50V	C386	1-164-232-11	CERAMIC CHIP	0.01uF 50V
C332	1-164-232-11	CERAMIC CHIP	0.01uF 50V				(HiFi)
C333	1-124-589-11	ELECT	47uF 20% 16V	C391	1-164-232-11	CERAMIC CHIP	0.01uF 50V
							(HiFi)
C334	1-137-374-11	FILM	0.047uF 5% 50V	C396	1-126-163-11	ELECT	4.7uF 20% 50V
C340	1-164-232-11	CERAMIC CHIP	0.01uF 50V				(MONO)
				C398	1-163-016-00	CERAMIC CHIP	0.0039uF 10% 50V
							(HiFi)
C341	1-124-589-11	ELECT	47uF 20% 16V	C399	1-163-016-00	CERAMIC CHIP	0.0039uF 10% 50V
			(HiFi)				(HiFi)
C342	1-164-004-11	CERAMIC CHIP	0.1uF 10% 25V				(HiFi)
			(HiFi)				
C346	1-164-232-11	CERAMIC CHIP	0.01uF 50V				
			(HiFi)				
C350	1-164-004-11	CERAMIC CHIP	0.1uF 10% 25V				
			(HiFi)				
C352	1-163-009-11	CERAMIC CHIP	0.001uF 10% 50V				
			(HiFi)				

Ref. No.	Part No.	Description	Remarks	Ref. No.	Part No.	Description	Remarks
C405	1-164-232-11	CERAMIC CHIP	0.01uF	50V	C735	1-126-964-11	ELECT 10uF 20% 50V
C421	1-124-589-11	ELECT	47uF	20% 16V			(HiFi)
C422	1-124-589-11	ELECT	47uF	20% 16V	C736	1-126-967-11	ELECT 47uF 20% 16V
C423	1-164-232-11	CERAMIC CHIP	0.01uF	50V			(HiFi)
C424	1-164-159-21	CERAMIC	0.1uF	50V	C980	1-163-038-00	CERAMIC CHIP 0.1uF 25V (688HF)
C501	1-163-237-11	CERAMIC CHIP	27PF	5% 50V	C981	1-124-589-11	ELECT 47uF 20% 16V (688HF)
C502	1-163-239-11	CERAMIC CHIP	33PF	5% 50V	C982	1-163-038-00	CERAMIC CHIP 0.1uF 25V (688HF)
C503	1-163-239-11	CERAMIC CHIP	33PF	5% 50V	C983	1-163-038-00	CERAMIC CHIP 0.1uF 25V (688HF)
C504	1-163-239-11	CERAMIC CHIP	33PF	5% 50V	C984	1-163-009-11	CERAMIC CHIP 0.001uF 10% 50V (688HF)
C506	1-164-232-11	CERAMIC CHIP	0.01uF	50V	C985	1-163-017-00	CERAMIC CHIP 0.0047uF 5% 50V (688HF)
C507	1-164-232-11	CERAMIC CHIP	0.01uF	50V	C986	1-163-038-00	CERAMIC CHIP 0.1uF 25V (688HF)
C509	1-126-160-11	ELECT	1uF	20% 50V			< PIN JACK >
C510	1-163-259-91	CERAMIC CHIP	220PF	5% 50V	CJ570	1-779-010-11	JACK, PIN 4P (LINE 1 IN/OUT) (MONO)
C511	1-164-004-11	CERAMIC CHIP	0.1uF	10% 25V	CJ570	1-779-011-11	JACK, PIN 6P (LINE 1 IN/OUT) (HiFi)
C512	1-126-160-11	ELECT	1uF	20% 50V			< CONNECTOR >
C513	1-163-227-11	CERAMIC CHIP	10PF	0.5PF 50V	CN101	1-779-724-11	CONNECTOR, BOARD TO BOARD 5P
C560	1-163-009-11	CERAMIC CHIP	0.001uF	10% 50V	CN102	1-779-723-11	CONNECTOR, BOARD TO BOARD 9P
C561	1-126-935-11	ELECT	470uF	20% 6.3V	* CN103	1-766-716-11	CONNECTOR, BOARD TO BOARD 3P
C563	1-126-967-11	ELECT	47uF	20% 16V	CN161	1-506-468-11	PIN, CONNECTOR 3P
C564	1-164-232-11	CERAMIC CHIP	0.01uF	50V	CN260	1-563-585-11	CONNECTOR, FLEXIBLE 8P (MONO)
△ C600	1-104-705-11	FILM	0.1uF	20% 250V	CN260	1-766-986-11	CONNECTOR, FFC/FPC 13P (HiFi)
△ C601	1-113-920-11	CERAMIC	0.0022uF	20% 250V	* CN261	1-560-892-00	PIN, CONNECTOR 4P
△ C601	1-115-385-11	CERAMIC	0.0022uF	20% 125V	CN301	1-506-469-11	PIN, CONNECTOR 4P
△ C602	1-119-911-51	CERAMIC	470PF	10% 250V	CN302	1-506-468-11	PIN, CONNECTOR 3P
△ C603	1-119-911-51	CERAMIC	470PF	10% 250V	* CN341	1-560-891-00	PIN, CONNECTOR 3P (HiFi)
△ C604	1-119-912-51	CERAMIC	1000PF	20% 250V	CN401	1-506-469-11	PIN, CONNECTOR 4P (EXCEPT L57,L58,L77HF,L78HF,X50)
C605	1-119-882-41	ELECT (BLOCK)	120uF	20% 200V	CN401	1-506-474-11	PIN, CONNECTOR 9P (L57,L58,L77HF,L78HF,X50)
C606	1-107-905-11	ELECT	4.7uF	20% 50V	CN423	1-506-469-11	PIN, CONNECTOR 4P (L57,L58,X50)
C607	1-113-681-11	FILM	0.033uF	10% 400V	CN423	1-506-470-11	PIN, CONNECTOR 5P (688HF,L77HF,L78HF)
C608	1-162-558-11	CERAMIC	100PF	10% 2KV	CN600	1-580-230-11	PIN, CONNECTOR (PC BOARD) 2P
C610	1-137-374-11	FILM	0.047uF	5% 50V			< JACK >
C611	1-137-374-11	FILM	0.047uF	5% 50V	CNJ980	1-779-013-11	JACK, MINIATURE (CONTROL S OUT)(688HF)
C612	1-126-160-11	ELECT	1uF	20% 50V			< DIODE >
C613	1-111-016-11	ELECT	0.0012F	20% 10V	D103	8-719-048-26	DIODE GL528V1
C614	1-115-789-11	ELECT	0.001F	20% 25V	D109	8-719-200-82	DIODE 11ES2
C615	1-126-967-11	ELECT	47uF	20% 50V	D161	8-719-200-82	DIODE 11ES2
C616	1-126-941-11	ELECT	470uF	20% 25V	D162	8-719-200-82	DIODE 11ES2
C617	1-126-935-11	ELECT	470uF	20% 16V	D382	8-719-048-07	DIODE M1MA151WKT1 (MONO)
C618	1-126-934-11	ELECT	220uF	20% 16V	D383	8-719-048-07	DIODE M1MA151WKT1 (MONO)
C619	1-124-248-00	ELECT	22uF	20% 35V	D405	8-719-056-07	DIODE SLR-342MC3F
C620	1-164-232-11	CERAMIC CHIP	0.01uF	50V	D501	8-719-911-19	DIODE 1SS119
C621	1-164-232-11	CERAMIC CHIP	0.01uF	50V	D560	8-719-109-74	DIODE RD4.3ES-B1
C622	1-128-131-11	ELECT	22uF	20% 50V	D600	8-719-051-93	DIODE DF06M-6031
C623	1-126-967-11	ELECT	47uF	20% 16V			
C624	1-126-967-11	ELECT	47uF	20% 16V			
C625	1-126-967-11	ELECT	47uF	20% 16V			
C626	1-126-965-11	ELECT	22uF	20% 50V			
C627	1-126-965-11	ELECT	22uF	20% 50V			
C628	1-164-232-11	CERAMIC CHIP	0.01uF	50V			
C629	1-124-234-00	ELECT	22uF	20% 16V			
C701	1-126-967-11	ELECT	47uF	20% 16V			
C706	1-126-963-11	ELECT	4.7uF	20% 50V			
C707	1-164-161-11	CERAMIC CHIP	0.0022uF	10% 100V			
C708	1-126-933-11	ELECT	100uF	20% 16V			
C709	1-126-933-11	ELECT	100uF	20% 16V			
C710	1-164-232-11	CERAMIC CHIP	0.01uF	50V			
C711	1-163-022-00	CERAMIC CHIP	0.012uF	10% 50V (MONO)			
C712	1-126-933-11	ELECT	100uF	20% 16V			
C713	1-163-009-11	CERAMIC CHIP	0.001uF	10% 50V			
C733	1-126-160-11	ELECT	1uF	20% 50V			

<p>Note : The components identified by mark △ or dotted line with mark △ are critical for safety. Replace only with part number specified.</p>	<p>Note : Les composants identifiés par une marque △ sont critiques pour la sécurité. Ne les remplacer que par une pièce portant le numéro spécifié.</p>
---	---

MA-317

Ref. No.	Part No.	Description	Remarks	Ref. No.	Part No.	Description	Remarks
D601	8-719-054-32	DIODE ERA15-06TP3				< JUMPER RESISTOR >	
D602	8-719-058-91	DIODE AG01A-V0		JR001	1-216-295-00	METAL CHIP 0 5%	1/10W
D603	8-719-200-82	DIODE 11ES2		JR002	1-216-296-00	METAL CHIP 0 5%	1/8W
D604	8-719-109-62	DIODE RD3.0ES-B1		JR003	1-216-295-00	METAL CHIP 0 5%	1/10W
D605	8-719-911-19	DIODE 1SS119		JR004	1-216-295-00	METAL CHIP 0 5%	1/10W
D606	8-719-313-17	DIODE AU02A-V0		JR005	1-216-296-00	METAL CHIP 0 5%	1/8W
D607	8-719-022-97	DIODE D2S4MF		JR006	1-216-296-00	METAL CHIP 0 5%	1/8W
D608	8-719-510-73	DIODE S3L20UF4		JR007	1-216-295-00	METAL CHIP 0 5%	1/10W
D609	8-719-313-17	DIODE AU02A-V0		JR008	1-216-296-00	METAL CHIP 0 5%	1/8W
D610	8-719-160-64	DIODE RD16F-B1		JR009	1-216-296-00	METAL CHIP 0 5%	1/8W
D611	8-719-911-19	DIODE 1SS119		JR010	1-216-295-00	METAL CHIP 0 5%	1/10W
D612	8-719-109-85	DIODE RD5.1ES-B2		JR011	1-216-295-00	METAL CHIP 0 5%	1/10W
D616	8-719-109-85	DIODE RD5.1ES-B2		JR012	1-216-296-00	METAL CHIP 0 5%	1/8W
D702	8-719-150-92	DIODE RD33ES-T1B		JR013	1-216-296-00	METAL CHIP 0 5%	1/8W
D980	8-719-110-08	DIODE RD8.2ES-B2 (688HF)		JR014	1-216-296-00	METAL CHIP 0 5%	1/8W
D981	8-719-110-08	DIODE RD8.2ES-B2 (688HF)		JR015	1-216-295-00	METAL CHIP 0 5%	1/10W
D982	8-719-911-19	DIODE 1SS119 (688HF)		JR016	1-216-296-00	METAL CHIP 0 5%	1/8W
		< TERMINAL BOARD >		JR017	1-216-296-00	METAL CHIP 0 5%	1/8W
ET600	1-537-770-21	TERMINAL BOARD, GROUND		JR018	1-216-296-00	METAL CHIP 0 5%	1/8W
ET601	1-537-770-21	TERMINAL BOARD, GROUND		JR019	1-216-296-00	METAL CHIP 0 5%	1/8W
		< FUSE >		JR020	1-216-296-00	METAL CHIP 0 5%	1/8W
△ F600	1-532-743-11	FUSE, GLASS CYLINDRICAL(DIA.5)		JR021	1-216-295-00	METAL CHIP 0 5%	1/10W
		< FERRITE BEAD >		JR022	1-216-296-00	METAL CHIP 0 5%	1/8W
FB601	1-410-858-21	INDUCTOR 0UH		JR023	1-216-296-00	METAL CHIP 0 5%	1/8W
		< FUSE HOLDER >		JR024	1-216-296-00	METAL CHIP 0 5%	1/8W
FH600	1-533-223-11	HOLDER, FUSE		JR025	1-216-296-00	METAL CHIP 0 5%	1/8W
FH601	1-533-223-11	HOLDER, FUSE		JR026	1-216-296-00	METAL CHIP 0 5%	1/8W
		< IC >		JR027	1-216-295-00	METAL CHIP 0 5%	1/10W
IC101	8-759-481-46	IC LB1943		JR028	1-216-296-00	METAL CHIP 0 5%	1/8W
IC160	8-759-491-00	IC M37777M7A229GP-B (478,677HF,678HF)		JR029	1-216-296-00	METAL CHIP 0 5%	1/8W
IC160	8-759-525-07	IC M37777M7A235GP-C (688HF)		JR030	1-216-296-00	METAL CHIP 0 5%	1/8W
IC160	8-759-525-08	IC M37777M7A237GP-B (EXCEPT 478,677HF,678HF,688HF)		JR031	1-216-296-00	METAL CHIP 0 5%	1/8W
IC161	8-759-432-32	IC ST24W02FM6TR		JR032	1-216-296-00	METAL CHIP 0 5%	1/8W
IC162	8-759-248-87	IC MM1256XF-BE		JR033	1-216-295-00	METAL CHIP 0 5%	1/10W
IC201	8-759-488-74	IC LA71534M-MPB		JR034	1-216-296-00	METAL CHIP 0 5%	1/8W
IC202	8-759-439-51	IC LC89978M-TE-L		JR035	1-216-296-00	METAL CHIP 0 5%	1/8W
IC260	8-759-352-17	IC HA118195NT		JR036	1-216-296-00	METAL CHIP 0 5%	1/8W
IC301	8-759-499-30	IC BA7755AF-E2		JR037	1-216-296-00	METAL CHIP 0 5%	1/8W
IC340	8-759-486-92	IC LA7256 (HiFi)		JR038	1-216-296-00	METAL CHIP 0 5%	1/8W
IC360	8-759-486-63	IC TDA9615H/N1,518 (L67HF,L68HF,L77HF,L78HF,X60HF)		JR039	1-216-296-00	METAL CHIP 0 5%	1/8W
IC360	8-759-486-64	IC TDA9615H/N1,557 (677HF,678HF,688HF)		JR040	1-216-296-00	METAL CHIP 0 5%	1/8W
IC403	8-742-042-00	HY B IC SBX1986-51		JR041	1-216-295-00	METAL CHIP 0 5%	1/10W
IC420	8-759-366-44	IC uPD16312GB-3B4		JR042	1-216-296-00	METAL CHIP 0 5%	1/8W
IC501	8-759-467-71	IC BU6188AFS-E2		JR043	1-216-296-00	METAL CHIP 0 5%	1/8W
IC601	8-759-438-18	IC PQ12RD08		JR044	1-216-296-00	METAL CHIP 0 5%	1/8W
△ IC602	8-759-321-95	IC HA17431PA-TZ		JR045	1-216-295-00	METAL CHIP 0 5%	1/10W
IC733	8-598-438-00	IC SOUND MULTIPLEX MODULE MPA-450 (L67HF,L68HF,L77HF,L78HF,X60HF)		JR046	1-216-295-00	METAL CHIP 0 5%	1/10W
IC733	8-742-037-00	HY B IC SBX1837-51 (677HF,678HF,688HF)		JR047	1-216-295-00	METAL CHIP 0 5%	1/10W
IC980	8-759-356-27	IC NJM2129M-TE2 (688HF)		JR048	1-216-296-00	METAL CHIP 0 5%	1/8W
		< IF BLOCK >		JR049	1-216-295-00	METAL CHIP 0 5%	1/10W
IF702	1-475-548-11	IF UNIT (IFZ-450ST) (US,Canadian)		JR050	1-216-295-00	METAL CHIP 0 5%	1/10W
IF702	1-475-548-21	IF UNIT (IFZ-450ST) (EXCEPT US,Canadian)		JR051	1-216-296-00	METAL CHIP 0 5%	1/8W

<p>Note : The components identified by mark △ or dotted line with mark △ are critical for safety. Replace only with part number specified.</p>	<p>Note : Les composants identifiés par une marque △ sont critiques pour la sécurité. Ne les remplacer que par une pièce portant le numéro spécifié.</p>
---	---

Ref. No.	Part No.	Description	Remarks	Ref. No.	Part No.	Description	Remarks
JR056	1-216-295-00	METAL CHIP	0 5% 1/10W			< FLUORESCENT INDICATOR >	
JR057	1-216-296-00	METAL CHIP	0 5% 1/8W				
JR058	1-216-295-00	METAL CHIP	0 5% 1/10W				
JR059	1-216-296-00	METAL CHIP	0 5% 1/8W	ND420	1-517-732-11	TUBE, FLUORESCENT INDICATOR	
JR060	1-216-296-00	METAL CHIP	0 5% 1/8W			< PHOTO INTERRUPTER >	
JR061	1-216-296-00	METAL CHIP	0 5% 1/8W	PH101	8-749-013-23	PHOTO INTERRUPTER GP3S120	
JR062	1-216-295-00	METAL CHIP	0 5% 1/10W	PH102	8-749-013-23	PHOTO INTERRUPTER GP3S120	
JR063	1-216-296-00	METAL CHIP	0 5% 1/8W	△ PH600	8-749-014-24	COUPLER, PHOTO ON3131-S (LF)	
JR064	1-216-296-00	METAL CHIP	0 5% 1/8W			< IC LINK >	
JR065	1-216-296-00	METAL CHIP	0 5% 1/8W				
JR066	1-216-296-00	METAL CHIP	0 5% 1/8W	△ PS101	1-533-586-11	LINK, IC 315mA	
JR067	1-216-296-00	METAL CHIP	0 5% 1/8W	△ PS600	1-533-592-11	LINK, IC 1.6A	
JR068	1-216-296-00	METAL CHIP	0 5% 1/8W			< TRANSISTOR >	
JR069	1-216-295-00	METAL CHIP	0 5% 1/10W				
JR070	1-216-296-00	METAL CHIP	0 5% 1/8W				
JR071	1-216-296-00	METAL CHIP	0 5% 1/8W	Q101	8-729-042-88	TRANSISTOR RPT-37PBT32	
JR072	1-216-296-00	METAL CHIP	0 5% 1/8W	Q102	8-729-042-88	TRANSISTOR RPT-37PBT32	
JR073	1-216-296-00	METAL CHIP	0 5% 1/8W	Q103	8-729-281-53	TRANSISTOR 2SC1815-GR	
JR074	1-216-295-00	METAL CHIP	0 5% 1/10W	Q201	8-729-230-49	TRANSISTOR 2SC2712-G	
JR075	1-216-295-00	METAL CHIP	0 5% 1/10W	Q202	8-729-230-49	TRANSISTOR 2SC2712-G	
JR076	1-216-295-00	METAL CHIP	0 5% 1/10W	Q208	8-729-230-49	TRANSISTOR 2SC2712-G	
JR351	1-216-295-00	METAL CHIP	0 5% 1/10W (HiFi)	Q209	8-729-216-21	TRANSISTOR 2SA1162Y-TE85L	
JR352	1-216-296-00	METAL CHIP	0 5% 1/8W (HiFi)	Q210	8-729-230-49	TRANSISTOR 2SC2712-G	
JR353	1-216-295-00	METAL CHIP	0 5% 1/10W (HiFi)	Q211	8-729-230-49	TRANSISTOR 2SC2712-G	
JR354	1-216-296-00	METAL CHIP	0 5% 1/8W (HiFi)	Q260	8-729-230-49	TRANSISTOR 2SC2712-G	
JR355	1-216-295-00	METAL CHIP	0 5% 1/10W (HiFi)	Q301	8-729-281-53	TRANSISTOR 2SC1815-GR	
		< JUMPER RESISTOR >		Q331	8-729-802-91	TRANSISTOR 2SD879	
JS324	1-216-295-00	METAL CHIP	0 5% 1/10W (MONO)	Q387	8-729-230-49	TRANSISTOR 2SC2712-G (MONO)	
		< COIL >		Q401	8-729-421-22	TRANSISTOR UN2211	
L161	1-414-936-21	INDUCTOR	22uH	Q501	8-729-216-21	TRANSISTOR 2SA1162Y-TE85L	
L163	1-414-936-21	INDUCTOR	22uH	Q502	8-729-010-05	TRANSISTOR MSB709-RT1	
L201	1-414-946-21	INDUCTOR	39uH	Q560	8-729-010-05	TRANSISTOR MSB709-RT1	
L202	1-414-940-21	INDUCTOR	100uH	Q601	8-729-904-98	TRANSISTOR 2SC4054P	
L204	1-414-940-21	INDUCTOR	100uH	Q602	8-729-012-31	TRANSISTOR 2SC4040-TL2-Q	
L261	1-414-939-21	INDUCTOR	68uH	Q603	8-729-140-98	TRANSISTOR 2SD773	
L262	1-414-940-21	INDUCTOR	100uH	Q604	8-729-010-25	TRANSISTOR MSD601-RT1	
L263	1-414-940-21	INDUCTOR	100uH	Q605	8-729-140-93	TRANSISTOR 2SB733-34	
L331	1-414-940-21	INDUCTOR	100uH			< RESISTOR >	
L341	1-414-940-21	INDUCTOR	100uH (HiFi)	R101	1-249-413-11	CARBON 470 5% 1/4W F	
L502	1-414-936-21	INDUCTOR	22uH	R102	1-216-089-00	METAL CHIP 47K 5% 1/10W	
L560	1-414-940-21	INDUCTOR	100uH	R103	1-216-089-00	METAL CHIP 47K 5% 1/10W	
L601	1-403-588-11	INDUCTOR	0uH	R104	1-216-081-00	METAL CHIP 22K 5% 1/10W	
L602	1-403-588-11	INDUCTOR	0uH	R105	1-216-081-00	METAL CHIP 22K 5% 1/10W	
L603	1-410-526-11	INDUCTOR	10uH	R106	1-249-400-11	CARBON 39 5% 1/4W F	
L604	1-410-519-11	INDUCTOR	68uH	R107	1-249-400-11	CARBON 39 5% 1/4W F	
L702	1-414-938-21	INDUCTOR	47uH	R109	1-216-089-00	METAL CHIP 47K 5% 1/10W	
L703	1-414-930-21	INDUCTOR	2.2uH	R110	1-216-089-00	METAL CHIP 47K 5% 1/10W	
L704	1-414-938-21	INDUCTOR	47uH	R111	1-216-057-00	METAL CHIP 2.2K 5% 1/10W	
L731	1-414-934-21	INDUCTOR	10uH (HiFi)	R112	1-216-065-00	METAL CHIP 4.7K 5% 1/10W	
		< LINE FILTER >		R115	1-216-089-00	METAL CHIP 47K 5% 1/10W	
LF600	1-424-117-11	FILTER, LINE		R116	1-216-089-00	METAL CHIP 47K 5% 1/10W	
				R117	1-216-041-00	METAL CHIP 470 5% 1/10W	
				R118	1-216-089-00	METAL CHIP 47K 5% 1/10W	
				R119	1-216-077-00	METAL CHIP 15K 5% 1/10W	
				R120	1-249-417-11	CARBON 1K 5% 1/4W F	
				R121	1-216-077-00	METAL CHIP 15K 5% 1/10W	
				R122	1-216-073-00	METAL CHIP 10K 5% 1/10W	
				R124	1-216-065-00	METAL CHIP 4.7K 5% 1/10W	

<p>Note : The components identified by mark △ or dotted line with mark △ are critical for safety. Replace only with part number specified.</p>	<p>Note : Les composants identifiés par une marque △ sont critiques pour la sécurité. Ne les remplacer que par une pièce portant le numéro spécifié.</p>
---	---

MA-317

Ref. No.	Part No.	Description	Remarks			Ref. No.	Part No.	Description	Remarks		
R160	1-216-049-00	METAL CHIP	1K	5%	1/10W (688HF)	R268	1-216-081-00	METAL CHIP	22K	5%	1/10W
R162	1-216-113-00	METAL CHIP	470K	5%	1/10W	R269	1-216-049-00	METAL CHIP	1K	5%	1/10W
R163	1-216-105-91	RES,CHIP	220K	5%	1/10W	R270	1-216-081-00	METAL CHIP	22K	5%	1/10W
R164	1-216-295-00	METAL CHIP	0	5%	1/10W (478,688HF,L57,L58,X50)	R271	1-216-049-00	METAL CHIP	1K	5%	1/10W
R165	1-216-295-00	METAL CHIP	0	5%	1/10W (L67HF,L68HF,X60HF)	R272	1-216-077-00	METAL CHIP	15K	5%	1/10W
R166	1-216-295-00	METAL CHIP	0	5%	1/10W (L77HF,L78HF)	R273	1-216-077-00	METAL CHIP	15K	5%	1/10W
R167	1-216-121-91	RES,CHIP	1M	5%	1/10W	R274	1-216-073-00	METAL CHIP	10K	5%	1/10W
R168	1-216-039-00	METAL CHIP	390	5%	1/10W	R275	1-216-073-00	METAL CHIP	10K	5%	1/10W
R169	1-218-179-11	RES,CHIP	10M	5%	1/10W	R276	1-216-049-00	METAL CHIP	1K	5%	1/10W
R170	1-216-073-00	METAL CHIP	10K	5%	1/10W	R301	1-216-089-00	METAL CHIP	47K	5%	1/10W (MONO)
R171	1-216-061-00	METAL CHIP	3.3K	5%	1/10W	R301	1-216-093-00	METAL CHIP	68K	5%	1/10W (HiFi)
R172	1-216-089-00	METAL CHIP	47K	5%	1/10W	R302	1-216-067-00	METAL CHIP	5.6K	5%	1/10W
R173	1-216-089-00	METAL CHIP	47K	5%	1/10W	R303	1-249-439-11	CARBON	68K	5%	1/4W (MONO)
R174	1-249-437-11	CARBON	47K	5%	1/4W	R304	1-249-439-11	CARBON	68K	5%	1/4W (L57,L58,X50)
R176	1-216-041-00	METAL CHIP	470	5%	1/10W	R305	1-216-067-00	METAL CHIP	5.6K	5%	1/10W (MONO)
R177	1-216-041-00	METAL CHIP	470	5%	1/10W	R306	1-216-073-00	METAL CHIP	10K	5%	1/10W
R178	1-216-041-00	METAL CHIP	470	5%	1/10W	R307	1-216-061-00	METAL CHIP	3.3K	5%	1/10W
R179	1-247-843-11	CARBON	3.3K	5%	1/4W	R308	1-216-067-00	METAL CHIP	5.6K	5%	1/10W (L57,L58,X50)
R180	1-247-843-11	CARBON	3.3K	5%	1/4W	R309	1-216-067-00	METAL CHIP	5.6K	5%	1/10W
R181	1-216-051-00	METAL CHIP	1.2K	5%	1/10W	R310	1-216-129-00	METAL CHIP	2.2M	5%	1/10W
R182	1-216-049-00	METAL CHIP	1K	5%	1/10W	R311	1-216-051-00	METAL CHIP	1.2K	5%	1/10W
R183	1-216-073-00	METAL CHIP	10K	5%	1/10W	R312	1-216-079-00	METAL CHIP	18K	5%	1/10W
R201	1-216-041-00	METAL CHIP	470	5%	1/10W	R313	1-216-109-00	METAL CHIP	330K	5%	1/10W
R202	1-216-069-00	METAL CHIP	6.8K	5%	1/10W	R314	1-216-035-00	METAL CHIP	270	5%	1/10W
R203	1-216-049-00	METAL CHIP	1K	5%	1/10W	R315	1-216-067-00	METAL CHIP	5.6K	5%	1/10W
R204	1-216-047-91	RES,CHIP	820	5%	1/10W	R316	1-216-071-00	METAL CHIP	8.2K	5%	1/10W
R205	1-216-041-00	METAL CHIP	470	5%	1/10W	R317	1-216-079-00	METAL CHIP	18K	5%	1/10W
R206	1-216-041-00	METAL CHIP	470	5%	1/10W	R318	1-216-075-00	METAL CHIP	12K	5%	1/10W
R208	1-216-071-00	METAL CHIP	8.2K	5%	1/10W	R319	1-216-190-00	RES,CHIP	470	5%	1/8W (MONO)
R209	1-216-295-00	METAL CHIP	0	5%	1/10W	R319	1-216-295-00	METAL CHIP	0	5%	1/10W (HiFi)
R210	1-216-295-00	METAL CHIP	0	5%	1/10W	R320	1-216-047-91	RES,CHIP	820	5%	1/10W
R218	1-208-798-11	RES,CHIP	4.7K	0.50%	1/10W	R331	1-217-671-11	METAL CHIP	1	5%	1/10W
R219	1-216-053-00	METAL CHIP	1.5K	5%	1/10W	R332	1-216-063-91	RES,CHIP	3.9K	5%	1/10W
R220	1-216-025-91	RES,CHIP	100	5%	1/10W	R333	1-249-401-11	CARBON	47	5%	1/4W F
R222	1-216-051-00	METAL CHIP	1.2K	5%	1/10W	R334	1-216-031-00	METAL CHIP	180	5%	1/10W
R228	1-216-057-00	METAL CHIP	2.2K	5%	1/10W	R341	1-216-049-00	METAL CHIP	1K	5%	1/10W (HiFi)
R229	1-216-055-00	METAL CHIP	1.8K	5%	1/10W	R342	1-216-049-00	METAL CHIP	1K	5%	1/10W (HiFi)
R230	1-216-045-00	METAL CHIP	680	5%	1/10W	R344	1-216-055-00	METAL CHIP	1.8K	5%	1/10W (HiFi)
R231	1-216-071-00	METAL CHIP	8.2K	5%	1/10W	R346	1-216-065-00	METAL CHIP	4.7K	5%	1/10W (HiFi)
R232	1-249-420-11	CARBON	1.8K	5%	1/4W F	R347	1-216-065-00	METAL CHIP	4.7K	5%	1/10W (HiFi)
R234	1-216-049-00	METAL CHIP	1K	5%	1/10W	R348	1-216-033-00	METAL CHIP	220	5%	1/10W (HiFi)
R235	1-216-295-00	METAL CHIP	0	5%	1/10W	R368	1-216-133-00	METAL CHIP	3.3M	5%	1/10W (HiFi)
R236	1-216-049-00	METAL CHIP	1K	5%	1/10W	R370	1-216-065-00	METAL CHIP	4.7K	5%	1/10W (HiFi)
R239	1-216-057-00	METAL CHIP	2.2K	5%	1/10W	R371	1-208-820-11	RES,CHIP	39K	0.50%	1/10W (HiFi)
R240	1-216-049-00	METAL CHIP	1K	5%	1/10W	R372	1-216-065-00	METAL CHIP	4.7K	5%	1/10W (HiFi)
R243	1-216-061-00	METAL CHIP	3.3K	5%	1/10W						
R260	1-216-044-00	METAL CHIP	620	5%	1/10W						
R261	1-216-044-00	METAL CHIP	620	5%	1/10W						
R262	1-216-025-91	RES,CHIP	100	5%	1/10W						
R263	1-216-025-91	RES,CHIP	100	5%	1/10W						
R264	1-216-025-91	RES,CHIP	100	5%	1/10W						
R265	1-216-025-91	RES,CHIP	100	5%	1/10W						
R266	1-216-053-00	METAL CHIP	1.5K	5%	1/10W (HiFi)						
R266	1-216-055-00	METAL CHIP	1.8K	5%	1/10W (MONO)						
R267	1-216-073-00	METAL CHIP	10K	5%	1/10W						

Ref. No.	Part No.	Description	Remarks	Ref. No.	Part No.	Description	Remarks
R378	1-216-083-00	METAL CHIP	27K 5% 1/10W (HiFi)	R565	1-216-037-00	METAL CHIP	330 5% 1/10W
R379	1-216-049-00	METAL CHIP	1K 5% 1/10W (MONO)	△R600	1-219-779-51	CARBON	6.8M 10% 1/2W
R380	1-216-025-91	RES,CHIP	100 5% 1/10W (688HF,L77HF,L78HF)	R601	1-249-441-11	CARBON	100K 5% 1/4W
R381	1-216-025-91	RES,CHIP	100 5% 1/10W (688HF,L77HF,L78HF)	R602	1-249-441-11	CARBON	100K 5% 1/4W
R382	1-216-295-00	METAL CHIP	0 5% 1/10W (HiFi)	R603	1-249-429-11	CARBON	10K 5% 1/4W
R383	1-216-295-00	METAL CHIP	0 5% 1/10W (HiFi)	R604	1-216-427-00	METAL OXIDE	120 5% 1W F
R384	1-216-091-00	METAL CHIP	56K 5% 1/10W (HiFi)	R605	1-215-416-00	METAL	620 1% 1/6W
R385	1-216-091-00	METAL CHIP	56K 5% 1/10W (HiFi)	R606	1-249-402-11	CARBON	56 5% 1/4W F
R387	1-216-065-00	METAL CHIP	4.7K 5% 1/10W (MONO)	R607	1-215-902-11	METAL OXIDE	47K 5% 2W F
R389	1-216-073-00	METAL CHIP	10K 5% 1/10W (HiFi)	R608	1-249-401-11	CARBON	47 5% 1/4W F
R391	1-216-049-00	METAL CHIP	1K 5% 1/10W (HiFi)	R609	1-249-406-11	CARBON	120 5% 1/4W F
R392	1-216-049-00	METAL CHIP	1K 5% 1/10W (HiFi)	R610	1-208-789-11	RES,CHIP	2K 0.50% 1/10W
R393	1-216-295-00	METAL CHIP	0 5% 1/10W (HiFi)	R611	1-208-786-11	RES,CHIP	1.5K 0.50% 1/10W
R401	1-216-029-00	METAL CHIP	150 5% 1/10W	R613	1-260-091-11	CARBON	220 5% 1/2W
R402	1-249-437-11	CARBON	47K 5% 1/4W	R615	1-215-907-11	METAL OXIDE	22 5% 3W F
R408	1-216-073-00	METAL CHIP	10K 5% 1/10W	R616	1-215-857-11	METAL OXIDE	10 5% 1W F
R409	1-216-013-00	METAL CHIP	33 5% 1/10W	R617	1-249-412-11	CARBON	390 5% 1/4W F
R410	1-216-073-00	METAL CHIP	10K 5% 1/10W	R618	1-260-091-11	CARBON	220 5% 1/2W
R411	1-216-013-00	METAL CHIP	33 5% 1/10W	R619	1-249-413-11	CARBON	470 5% 1/4W F
R414	1-216-053-00	METAL CHIP	1.5K 5% 1/10W	R620	1-249-413-11	CARBON	470 5% 1/4W F
R415	1-216-053-00	METAL CHIP	1.5K 5% 1/10W	R622	1-216-061-00	METAL CHIP	3.3K 5% 1/10W
R417	1-249-421-11	CARBON	2.2K 5% 1/4W	R623	1-216-061-00	METAL CHIP	3.3K 5% 1/10W
R418	1-249-421-11	CARBON	2.2K 5% 1/4W	R624	1-216-430-11	METAL OXIDE	390 5% 1W F
R419	1-216-059-00	METAL CHIP	2.7K 5% 1/10W	R625	1-249-429-11	CARBON	10K 5% 1/4W
R420	1-216-059-00	METAL CHIP	2.7K 5% 1/10W	R630	1-216-049-00	METAL CHIP	1K 5% 1/10W
R421	1-216-295-00	METAL CHIP	0 5% 1/10W	R633	1-216-295-00	METAL CHIP	0 5% 1/10W
R422	1-216-049-00	METAL CHIP	1K 5% 1/10W	R637	1-260-073-11	CARBON	5.6 5% 1/2W
R423	1-216-049-00	METAL CHIP	1K 5% 1/10W	R638	1-260-073-11	CARBON	5.6 5% 1/2W
R424	1-216-049-00	METAL CHIP	1K 5% 1/10W	R701	1-216-049-00	METAL CHIP	1K 5% 1/10W
R425	1-216-085-00	METAL CHIP	33K 5% 1/10W	R702	1-216-061-00	METAL CHIP	3.3K 5% 1/10W
R426	1-216-065-00	METAL CHIP	4.7K 5% 1/10W	△R705	1-212-893-00	FUSIBLE	330 5% 1/4W F
R440	1-216-075-00	METAL CHIP	12K 5% 1/10W	R706	1-216-113-00	METAL CHIP	470K 5% 1/10W
R441	1-249-434-11	CARBON	27K 5% 1/4W	R709	1-249-417-11	CARBON	1K 5% 1/4W F
R445	1-216-065-00	METAL CHIP	4.7K 5% 1/10W (L57,L58,L77HF,L78HF,X50)	R710	1-249-417-11	CARBON	1K 5% 1/4W F
R502	1-216-049-00	METAL CHIP	1K 5% 1/10W	R711	1-249-417-11	CARBON	1K 5% 1/4W F
R503	1-216-049-00	METAL CHIP	1K 5% 1/10W	R712	1-216-295-00	METAL CHIP	0 5% 1/10W
R504	1-216-045-00	METAL CHIP	680 5% 1/10W	R713	1-216-067-00	METAL CHIP	5.6K 5% 1/10W (MONO)
R505	1-216-049-00	METAL CHIP	1K 5% 1/10W	R731	1-216-049-00	METAL CHIP	1K 5% 1/10W (HiFi)
R506	1-216-049-00	METAL CHIP	1K 5% 1/10W	R732	1-216-049-00	METAL CHIP	1K 5% 1/10W (HiFi)
R507	1-216-097-91	RES,CHIP	100K 5% 1/10W	R733	1-216-065-00	METAL CHIP	4.7K 5% 1/10W (HiFi)
R508	1-216-295-00	METAL CHIP	0 5% 1/10W	R734	1-216-049-00	METAL CHIP	1K 5% 1/10W (HiFi)
R560	1-216-022-00	METAL CHIP	75 5% 1/10W	R735	1-216-049-00	METAL CHIP	1K 5% 1/10W (HiFi)
R561	1-216-021-00	METAL CHIP	68 5% 1/10W	R736	1-216-295-00	METAL CHIP	0 5% 1/10W (HiFi)
R562	1-249-407-11	CARBON	150 5% 1/4W F	R737	1-216-081-00	METAL CHIP	22K 5% 1/10W (HiFi)
R563	1-249-408-11	CARBON	180 5% 1/4W F	R738	1-216-081-00	METAL CHIP	22K 5% 1/10W (HiFi)
				R748	1-216-065-00	METAL CHIP	4.7K 5% 1/10W (HiFi)
				R749	1-216-049-00	METAL CHIP	1K 5% 1/10W (HiFi)

<p>Note : The components identified by mark △ or dotted line with mark △ are critical for safety. Replace only with part number specified.</p>	<p>Note : Les composants identifiés par une marque △ sont critiques pour la sécurité. Ne les remplacer que par une pièce portant le numéro spécifié.</p>
---	---

MA-317

Ref. No.	Part No.	Description	Remarks
		< VARIABLE RESISTOR >	
RV731	1-241-766-11	RES, ADJ, CERMET 47K (HiFi)	
		< SWITCH >	
S101	1-762-108-11	SWITCH, PUSH (1 KEY) (CASSETTE IN/REC PROOF)	
S102	1-771-155-11	SWITCH, ROTARY (ROTARY ENCODER)	
S401	1-692-431-21	SWITCH, TACTILE (POWER)	
S402	1-692-431-21	SWITCH, TACTILE (EJECT)	
S403	1-692-431-21	SWITCH, TACTILE (REC)	
S404	1-692-431-21	SWITCH, TACTILE (PAUSE)	
S405	1-692-431-21	SWITCH, TACTILE (CHANNEL/TRACKING:+)	
S406	1-692-431-21	SWITCH, TACTILE (CHANNEL/TRACKING:-)	
S412	1-692-431-21	SWITCH, TACTILE (EASY SET UP)	
S701	1-571-588-11	SWITCH, SLIDE (3CH/4CH)	
		< TRANSFORMER >	
T331	1-431-097-11	TRANSFORMER, BIAS OSCILLATION	
△ T600	1-431-691-11	TRANSFORMER, CONVERTER (RCC)	
		< TUNER >	
TU701	1-693-399-12	TUNER, MODULATOR (BTF-2RA401) (US,Canadian)	
TU701	1-693-399-22	TUNER, MODULATOR (BTF-2RA401) (EXCEPT US,Canadian)	
		< VIBRATOR >	
X160	1-760-494-11	VIBRATOR, CRYSTAL 16MHZ	
X161	1-579-463-11	VIBRATOR, CRYSTAL 32.768kHz	
X202	1-577-380-11	VIBRATOR, CRYSTAL 3.579545MHZ	
X501	1-567-307-11	OSCILLATOR, CRYSTAL 7.15909MHZ	
		MISCELLANEOUS *****	
△ 8	1-777-851-41	CORD, POWER (478,677HF,678HF,688HF)	
△ 8	1-777-854-41	CORD, POWER (L47,L48,L57,L58,L67HF,L68HF,L77HF,L78HF,X50,X60HF)	
10	1-762-844-21	SWITCH, ROTARY (L57,L58,L77HF,L78HF,X50)	
55	1-779-725-11	CONNECTOR, BOARD TO BOARD 5P	
704	1-500-144-11	HEAD, FE	
721	A-6759-620-A	HEAD BLOCK ASSY, ACE (TDK)	
769	8-848-576-02	DRUM ASSY, UPPER DZR-45-R (HiFi)(NOTE)	
770	8-848-666-11	DRUM ASSY, LOWER DZL-51B/J-RP (M901) (HiFi)	
776	8-839-036-04	DRUM ASSY DZH-73D-ZRB (M901)(MONO)	
776	8-839-044-02	DRUM ASSY DZH-94A/Z-RP (M901)(HiFi) (NOTE)	
		ACCESSORIES & PACKING MATERIALS *****	
	1-475-552-11	COMMANDER, STANDARD (RMT-V230) (L47,L48)	
	1-475-553-11	COMMANDER, STANDARD (RMT-V231) (L67HF,L68HF,X60HF)	
	1-475-553-21	COMMANDER, STANDARD (RMT-V231A) (478,677HF,678HF)	

Ref. No.	Part No.	Description	Remarks
	1-475-553-31	COMMANDER, STANDARD (RMT-V231B) (688HF)	
	1-475-554-11	COMMANDER, STANDARD (RMT-V232) (L57,L58,L77HF,L78HF,X50)	
	1-575-334-11	CORD, CONNECTION (FOR AV) (HiFi)	
	3-861-446-11	MANUAL, INSTRUCTION (ENGLISH) (688HF)	
	3-861-447-11	MANUAL, INSTRUCTION (ENGLISH) (677HF,678HF)	
	3-861-447-21	MANUAL, INSTRUCTION (FRENCH) (677HF,678HF:Canadian)	
	3-861-448-11	MANUAL, INSTRUCTION (ENGLISH) (478)	
	3-861-448-21	MANUAL, INSTRUCTION (FRENCH) (478)	
	3-861-458-11	MANUAL, INSTRUCTION (SPANISH) (L57,L58,L77HF,L78HF)	
	3-861-459-11	MANUAL, INSTRUCTION (SPANISH) (L67HF,L68HF,X60HF)	
*	3-861-461-11	MANUAL, INSTRUCTION (SPANISH) (L47,L48)	
*	3-961-581-01	SHEET, PROTECTION	
*	3-979-708-01	INDIVIDUAL CARTON (678HF)	
*	3-979-708-11	INDIVIDUAL CARTON (688HF)	
*	3-979-708-21	INDIVIDUAL CARTON (478)	
*	3-979-708-32	INDIVIDUAL CARTON (677HF)	
*	3-979-709-01	CUSHION (478,677HF,678HF,688HF)	
*	3-979-710-01	SPACER (478,677HF,678HF,688HF)	
*	3-987-411-01	INDIVIDUAL CARTON (L47)	
*	3-987-411-11	INDIVIDUAL CARTON (L48)	
*	3-987-411-21	INDIVIDUAL CARTON (L57)	
*	3-987-411-31	INDIVIDUAL CARTON (L58)	
*	3-987-411-41	INDIVIDUAL CARTON (X50)	
*	3-987-411-51	INDIVIDUAL CARTON (L67HF)	
*	3-987-411-61	INDIVIDUAL CARTON (L68HF)	
*	3-987-411-71	INDIVIDUAL CARTON (X60HF)	
*	3-987-411-81	INDIVIDUAL CARTON (L77HF)	
*	3-987-411-91	INDIVIDUAL CARTON (L78HF)	
*	3-987-456-01	CUSHION (EXCEPT:478,677HF,678HF,688HF)	
*	3-987-457-01	SPACER (EXCEPT:478,677HF,678HF,688HF)	

***** HARDWARE LIST *****			
#1	7-685-646-79	SCREW +BVTP 3X8 TYPE2 IT-3 (478,677HF,678HF,688HF)	
#2	7-685-648-79	SCREW +BVTP 3X12 TYPE2 IT-3	
#3	7-682-547-04	SCREW +P 3X6	
#701	7-685-646-79	SCREW +BVTP 3X8 TYPE2 IT-3	
#702	7-682-547-04	SCREW +P 3X6	
#703	7-685-133-19	SCREW (DIA)(IT3B)	

Note :
The components identified by mark △ or dotted line with mark △ are critical for safety. Replace only with part number specified.

Note :
Les composants identifiés par une marque △ sont critiques pour la sécurité. Ne les remplacer que par une pièce portant le numéro spécifié.

**SLV-478/677HF/678HF/688HF/L47/L48/L57/
L58/L67HF/L68HF/L77HF/L78HF/X50/X60HF**